

***D^{term}*[®] Cordless DECT**

**Owner's Manual
DTZ-8R-1**

Contents of this manual are subject to change without prior notice at the discretion of **NEC Corporation of America**. This document has been prepared for the use of employees and customers of **NEC Corporation of America** and may not be reproduced without prior written approval of **NEC Corporation of America**.

D^{term} is a registered trademark of NEC Corporation.

Copyright 2017

NEC Corporation of America
3929 W John Carpenter Fwy
Irving, TX 75063

TABLE OF CONTENTS

Chapter 1 Specifications and Safety Information

Section 1	Regulatory Information	1-1
1.1	Certification Label	1-1
1.2	Safety Information	1-1
1.3	Radio Frequency Interference	1-1
1.4	Hearing Aid Compatibility and Volume Control	1-2
Section 2	Specifications	1-2
2.1	General	1-2
2.2	Base Unit	1-2
2.3	Handset	1-3
2.4	Battery Charging Unit	1-3
Section 3	Battery Safety	1-4
Section 4	Important Safety Instructions	1-4
Section 5	Privacy	1-6
Section 6	Important Electrical Considerations	1-6
6.1	Electrical Safety	1-6
6.2	Range	1-6
6.3	Telephone Line Problems	1-6
6.4	Radio Interference	1-7
6.5	More than One Cordless Telephone	1-7

Chapter 2 About the D^{term} Cordless DECT

Section 1	Overview	2-1
Section 2	Items Included with the D^{term} Cordless DECT	2-2
Section 3	Features of the Cordless Telephone	2-3
Section 4	D^{term} Controls and Functions	2-3

4.1	Handset	2-4
4.2	Base Unit	2-5
4.3	Cordless Handset/Desk Phone Switch (Base Key Option)	2-6
4.4	Charging Unit	2-7

Chapter 3 Installation

Section 1	Selecting a Location	3-1
Section 2	Installation Precautions	3-1
Section 3	Connecting the Telephone Cords	3-1
Section 4	Applying Power to the Charging Unit	3-3
Section 5	Wall Installation	3-4
5.1	Mounting the Base Directly to the Wall	3-4
Section 6	Attaching and Removing the Belt Clip	3-6
Section 7	Installing the Handset Batteries	3-7
Section 8	Charging Batteries	3-8
8.1	Charging the Handset Batteries	3-8
Section 9	Low Battery Indicator	3-9
9.1	Low Battery	3-9
9.2	Battery Status	3-9
Section 10	Cleaning the Battery Charging Contacts	3-10

Chapter 4 D^{term} Handset, Base Unit and Charging Unit

Section 1	Handset Controls	4-1
------------------	-------------------------------	------------

Chapter 5 Optional Equipment Installation

Section 1	Replacement Parts and Optional Accessories	5-1
Section 2	Installing the Optional Headset	5-2

Chapter 6 Setup and Operation

Section 1	Setting Up and Programming the DTZ-8R-1	6-1
1.1	Programming Mode	6-1
1.1.1	Training Mode (Entry)	6-1
1.1.2	Training Mode (Next Key [Softkey1] – Select Item)	6-2
1.1.3	Training Mode (Func Key [Softkey2] – Change Item)	6-2
1.1.4	Training Mode (Back Key [Softkey4] – Exit from Training Mode)	6-2
1.1.5	Training Mode (Volume Up Key – Change Each Item Setting)	6-2
Section 2	Handset Operation	6-5
2.1	Switching Between the Wired Phone and Cordless Phone (DTZ-8R-1 Handset)	6-5
2.2	Making a Call to Another Extension	6-6
2.2.1	Connection Considerations	6-9
2.3	Retrieving a Call to Another Extension	6-10
2.4	Making Call to Outside Line	6-11
2.5	Receiving a Call from an Outside Line (Depends on PBX Line)	6-13
2.6	Redial (Option)	6-15
2.7	AutoStandby®	6-15
2.8	PBX No Service	6-16
2.9	Out Of Range	6-16
2.10	Low Battery	6-18
2.11	Battery Status	6-18
2.12	Mute	6-18
2.13	Handsfree	6-18
2.14	Headset	6-19
2.15	Volume Setting	6-19
2.16	Ring Volume Setting	6-19
2.16.1	Ringer Tone/Volume Selection	6-19
2.17	Ringer Mute	6-20

Chapter 7 Handset Feature Settings

Section 1	Handset Features	7-1
Section 2	Main Menu	7-2
2.1	Accessing the Main Menu	7-2
Section 3	Main Menu Selections	7-3
3.1	Contacts	7-3
3.1.1	List All Contacts	7-3
3.1.2	Show Individual Contacts	7-4
3.1.3	Delete Contacts	7-5
3.1.4	Edit/Add Contacts	7-5
3.2	Settings	7-8
3.2.1	List Settings	7-8
3.2.2	Menu Timeout Settings	7-8
3.2.3	Brightness Settings	7-9
3.2.4	Power Save Settings	7-9
3.2.5	Key Lock Settings	7-10
3.3	Sounds	7-11
3.3.1	Sounds List Settings	7-11
3.3.2	Sounds Ring Tone Settings	7-11
3.3.3	Sounds Vibrate Settings	7-12
3.3.4	Sounds Out of Range Alert Settings	7-12
3.3.5	Sounds Key Tone Settings	7-13
3.4	Language	7-14
3.4.1	Language Settings	7-14
3.5	Administrator Settings	7-14
3.5.1	Administrator List Settings	7-15
3.5.2	Administrator Registration Settings	7-15
3.5.3	Administrator De-registration Settings	7-18
3.5.4	Administrator Change Pin Code Settings	7-20
3.5.5	Administrator Site Survey Settings	7-21
3.5.6	Administrator Site Survey Settings - Sync Display Mode	7-22
3.6	Function Key Labels	7-23
3.6.1	Key Label List Settings	7-23
3.6.2	Key Label Name Edit Settings	7-24
3.6.3	Key Label Delete Label Settings	7-25

Section 4 Additional Handset Features 7-26
4.1 Virtual Function Keys 7-26



LIST OF FIGURES AND TABLES

Chapter 2 ***About the D^{term} Cordless DECT***

Figure 2-1	<i>D^{term}</i> System Overview	2-1
Figure 2-2	Items Included with the <i>D^{term}</i> Cordless DECT	2-2
Figure 2-3	DTZ-8R-1 Handset Controls and Functions	2-4
Figure 2-4	Base Unit Controls and Functions	2-5
Figure 2-5	Charging Unit	2-7

Chapter 3 ***Installation***

Figure 3-1	Connecting Telephone Cords	3-2
Figure 3-2	Applying Power to the Charging Unit	3-3
Figure 3-3	Inserting Screws into the Wall for Wall Mounting the Telephone	3-4
Figure 3-4	Attaching the Base Directly to the Wall	3-5
Figure 3-5	Attaching the Belt Clip to the Handset	3-6
Figure 3-6	Removing the Belt Clip	3-6
Figure 3-7	Removing the Battery Cover	3-7
Figure 3-8	Installing the Batteries	3-7
Figure 3-9	Replacing the Battery Cover	3-8
Figure 3-10	Handset Charging LED Indicator	3-8
Figure 3-11	Low Battery Indicator	3-9
Figure 3-12	Cleaning Battery Charging Unit Contacts	3-10

Chapter 4 ***D^{term} Handset, Base Unit and Charging Unit***

Figure 4-1	Handset Controls	4-1
Table 4-1	Handset Control Functions	4-2
Figure 4-2	Base Unit Controls and Functions	4-4

Chapter 5 Optional Equipment Installation

Figure 5-1	Optional Accessories and Replacement Parts	5-1
Figure 5-2	Installing the Headset	5-2

This chapter provides specification and safety information for the DTZ-8R-1.

SECTION 1 REGULATORY INFORMATION

1.1 Certification Label

The product certification label can be found on the bottom surface of the main unit and inside the battery compartment of the handset. These labels have important safety and regulatory compliance information.

1.2 Safety Information

This product has been certified by Canadian Standards Association (CSA) and found to comply with all applicable requirements for North America:

- CAN/CSA C22.2 No. 0-M General Requirements - Canadian Electrical Code, Part II
- CAN/CSA-C22.2 No. 60950-1-07, 2nd Ed. Information Technology Equipment - Safety - Part 1: Amendment 1: 2011 (MOD) General Requirements (Bi-national Standard, with UL 60950-1-2011, 2nd Ed.)
- ANSI/UL Std No. 60950-1-2011, 2nd Ed. Information Technology Equipment - Safety - Part 1: General Requirements

1.3 Radio Frequency Interference

In compliance with FCC Part 15 rules, the following statements are provided.

Note:

This equipment has been tested and found to comply with the limits for a Class B digital device, pursuant to part 15 of the FCC Rules. These limits are designed to provide reasonable protection against harmful interference in a residential installation. This equipment generates, uses and can radiate radio frequency energy and, if not installed and used in accordance with the instructions, may cause harmful interference to radio communications. However, there is no guarantee that interference will not occur in a particular installation. If this equipment does cause harmful interference to radio or television reception, which can be determined by turning the equipment off and on, the user is encouraged to try to correct the interference by one or more of the following measures:

- Reorient or relocate the receiving antenna.
- Increase the separation between the equipment and receiver.
- Connect the equipment into an outlet on a circuit different from that to which the receiver is connected.
- Consult the dealer or an experienced radio/TV technician for help.



Changes or modifications not expressly approved by the party responsible for compliance could void the user's authority to operate the equipment.

For Canada: CAN ICES-3(B)/NMB-3(B)

1.4 Hearing Aid Compatibility and Volume Control

This equipment complies with Part 68 of the FCC rules as well as Industry Canada CS-03 Part V regarding Hearing Aid Compatibility (HAC) and Volume Control requirements.

SECTION 2 SPECIFICATIONS

2.1 General

Audio Process	Digital (ADPCM)
Channels	5
Frequency	1.9G (1920 ~ 1930 MHz)
ID #	130,000 combinations
Operating Temperature	0 ~ +50 C (+32 F to +122 F)
Remote Base and Separate Charging Unit	Yes
RoHs	Yes
Transmission	TDMA/TDD
Wi-Fi Friendly	Yes

2.2 Base Unit

Receive/Transmit Frequency	1920 ~ 1930 MHz
Power Requirements	9 Vdc from supplied AC adapter
Size	225mm (H) x 140mm (W) x 40mm (D)
Weight	410g

2.3 Handset

Any Key Answer	Yes (White)
Back Light - LCD	Yes (White)
Back Light - Keys	Yes (Orange)
Battery	Capacity 910 mAh, 2.4V
Channel Change	Auto
Handsfree	Yes
Handsfree Volume Control	Yes
Headset Jack	Yes
Headset Volume Control	Yes
Hearing Aid Compatible	Yes
LCD Display	240 x 320 dots (QVGA)
Out of Range Detection	Yes
Out of Range Alarm Tone	Yes (On/Off)
Power Requirements	AAA Ni-MH, 1.2V, 900mAh re-chargeable batteries (quantity 2)
Soft Keys	4
Receive/Transmit Frequency	1920 ~ 1930 MHz
Ringer Mute	Yes
Ringer Tone	Tones A~F
Ringer Volume	High, Low and Vibrate
Size	146mm (H) x 21.2mm (D) x 48mm (W)
Standby Mode	7 days (typical)
Talk Mode	16 hours (typical)
Vibrating Ringer	Yes
Volume Control	Yes (6 settings)
Weight	150g (Handset = 120g, including batteries)

2.4 Battery Charging Unit

Power Requirements	5.4V DC from supplied AC adapter
Size	45mm (H) x 85mm (D) x 68mm (W)

SECTION 3 BATTERY SAFETY



NOTE

To reduce the risk of fire or injury to persons by the batteries, read and follow these instructions.

- This equipment contains rechargeable nickel-metal hydride (Ni-MH) batteries.
- Do not** short-circuit the batteries.
- Do not** charge the rechargeable Ni-MH batteries used in this equipment in any charger other than the one designed to charge these batteries as specified in this manual. Using another charger can damage the batteries or cause the batteries to explode.
- Use only the appropriate type and size batteries specified in this manual.
- Do not** open or mutilate the batteries. Released electrolyte is corrosive and can cause damage to the eyes or skin. It may be toxic if swallowed.
- Exercise care in handling the batteries in order not to short the batteries with conducting materials such as rings, bracelets, and buttons, etc. Shorting the contacts on the batteries can cause overheating and burns.
- Observe proper polarity orientation when installing the batteries.
- Do not** dispose of the batteries in a fire; they may explode.
- Do not** place the batteries in your regular trash. Ni-MH batteries must be collected, recycled, or disposed of in an environmentally sound manner. Contact your local waste management officials for other information regarding the environmentally sound collection, recycling and disposal of the battery contained in this product.

SECTION 4 IMPORTANT SAFETY INSTRUCTIONS

When using the telephone equipment, basic safety precautions should always be followed to reduce the risk of fire, electrical shock, and injury to persons, including the following:

- Read and understand all instructions.
- Follow all warnings and instructions marked on the product.
- Unplug this product from the wall outlet before cleaning. **Do not** use liquid cleaners or aerosol cleaners. Use a dry cloth for cleaning.
- Do not** use this product near water; for example, near a sink or in a wet area.
- Do not** place this product on an unstable cart, stand, or table. The telephone can fall, causing serious damage to the unit.

- To protect the product from overheating, do not block or cover any slots or openings in the base unit. This product should never be placed near or over a radiator or heat register. This product should not be placed in a small enclosure unless proper ventilation is provided.
- This product should be operated only from the type of power source indicated on the marking labels.
- Do not** allow anything to rest on the power cords. Do not locate this product where the cords will be damaged by people walking on them.
- Do not** overload wall outlets and extension cords, as this can result in the risk of fire or electrical shock.
- Never push objects of any kind into this product through the base unit slots, as they may touch dangerous voltage points or short out parts that could result in a risk of fire or electrical shock. Never spill liquid of any kind on the product.
- To reduce the risk of electric shock, do not disassemble this product. Contact qualified service personnel when some service or repair work is required. Opening or removing covers may expose you to dangerous voltages or other risks. Incorrect reassembly can cause electric shock when the appliance is subsequently used.
- Unplug this product from the wall outlet and refer servicing to qualified service personnel under the following conditions:
 - If you see smoke coming from the unit, or if it smells burned.
 - When the power supply cord is damaged or frayed.
 - If liquid has been spilled onto the product.
 - If the product has been exposed to water or rain.
 - If the product does not operate normally when following the operating instructions. Adjust only those controls that are covered by the operating instructions. Improper adjustment of other controls can result in damage, and will often require extensive work by a qualified technician to restore the product to normal operation.
 - If the product has been dropped or damaged.
 - If the product exhibits a distinct change in performance.
- Do not** use the telephone to report a gas leak in the vicinity or the leak.
- To reduce the risk of fire or injury to persons by the battery, read and follow these instructions.
 - Use only the appropriate type and size batteries.
 - Exercise care in handling the batteries in order not to short them with conducting materials such as rings, bracelets, buttons, etc. Shorting the contacts on the batteries can cause overheating and burns.

SECTION 5 PRIVACY

Cordless telephones are radio frequency devices. Communications between the handset and base unit of the cordless telephone are accomplished by means of radio waves which are broadcast over the open airways. Because of the inherent physical properties of radio waves, communication can be received by radio receiving devices other than your own telephone unit; consequently, any communications using the cordless telephone may not be private.

SECTION 6 IMPORTANT ELECTRICAL CONSIDERATIONS

6.1 Electrical Safety



Do not attempt to unplug any appliance during an electrical storm.

Unplug all electrical appliances when you know an electrical storm is approaching. Lightning can pass through wiring and damage any device connected to it. This telephone is no exception.



Changes or modifications to this product not expressly approved by NEC Corporation of America, or operation of this product in any way other than as detailed by this manual, could void your authority to operate this product.

6.2 Range

Nominal values of the DECT system are:

- 164 feet (50 meters) – Indoor
- 984 feet (300 meters) – Outdoor

The telephone is designed to achieve a maximum range of up to 350 feet (depending upon the environment), by transmitting and receiving according to the highest specifications set forth by the FCC. This telephone has been rated to operate at a maximum distance with the qualification that the range depends upon the environment in which the telephone is used. Many factors limit range, and it would be impossible to include all of the variables in the rating. The maximum range rating of this telephone is meant to be used as a means of comparison against other range claims.

6.3 Telephone Line Problems

The FCC has granted the telephone company the right to disconnect service in the event that your telephone causes problems on the telephone line. Also, the telephone company may make changes in facilities and services which can affect

the operation of your unit. However, your telephone company must give adequate notice in writing prior to such actions to allow you time for making necessary arrangements to continue uninterrupted service.

If you are having trouble with your telephone service, you must first disconnect your telephone to determine if it is the cause of your problem. If you determine that it is the cause, you must leave it disconnected until the trouble has been corrected.

6.4 Radio Interference

Radio interference may occasionally cause buzzing and humming in your cordless handset, or clicking noises in the base unit. This interference is caused by external sources such as a PC, TV, fluorescent lighting, or electrical storm, etc. Your unit is NOT DEFECTIVE. If these noises continue and are too distracting, check around your office to see what appliances may be causing the problem. In addition, we recommend that the base unit not be plugged into a circuit that also powers a major appliance because of the potential of interference. For best performance, ensure that the antenna on the base unit is fully extended. It may also be necessary to re-locate the base unit

In the unlikely event that you consistently hear other voices or distracting transmissions on your telephone, you may be receiving radio signals for another cordless telephone or other source of interference.

Finally, it should be noted that some cordless telephones operate at frequencies that may cause interference to nearby TVs or other electronic equipment. To minimize or prevent such interference, the base of the cordless telephone should

not be placed near or on top of other electronic equipment. If interference is experienced, moving the cordless telephone unit farther away will often reduce or eliminate the interference.

6.5 More than One Cordless Telephone

If you want to use more than one cordless telephone in your office, they must operate on different channels and must be more than 20 feet (6m) apart.

If more than eight DTZ-8R-1s are used in the same area, there is a possibility that the following problem occurs:

- Difficulty connecting the Handset with the Base Unit
- Some noises can be heard during conversation

The DTZ-8R-1 is limited to five RF channels. The RF channel is changed automatically to find the best channel.

Depending on your environment, the maximum number of cordless devices used without interference varies.

Multiple base and handset units should not be closer than 20 feet (6m) at any time.

Radio interference causes interruptions in conversation. When this happens, your unit is not defective. When noise continues, move to a different location while you talk. (You might even need to move the base unit.) When the situation persists, contact the National Technical Assistance Center (NTAC).

SECTION 1 OVERVIEW

The DTZ-8R-1 (*D^{term}* Cordless DECT) is a cordless telephone for the NEC PBX (Private Branch Exchange) or key telephone system. It is designed for use in the office environment. Optionally, an NEC *D^{term}* multiline (wired) desk phone (such as DT400 series) can be connected. This gives the user the option of using either the cordless handset or the wired desk phone. However, in this configuration the Cordless Handset and wired phone cannot be used at the same time.

Figure 2-1 *D^{term}* System Overview

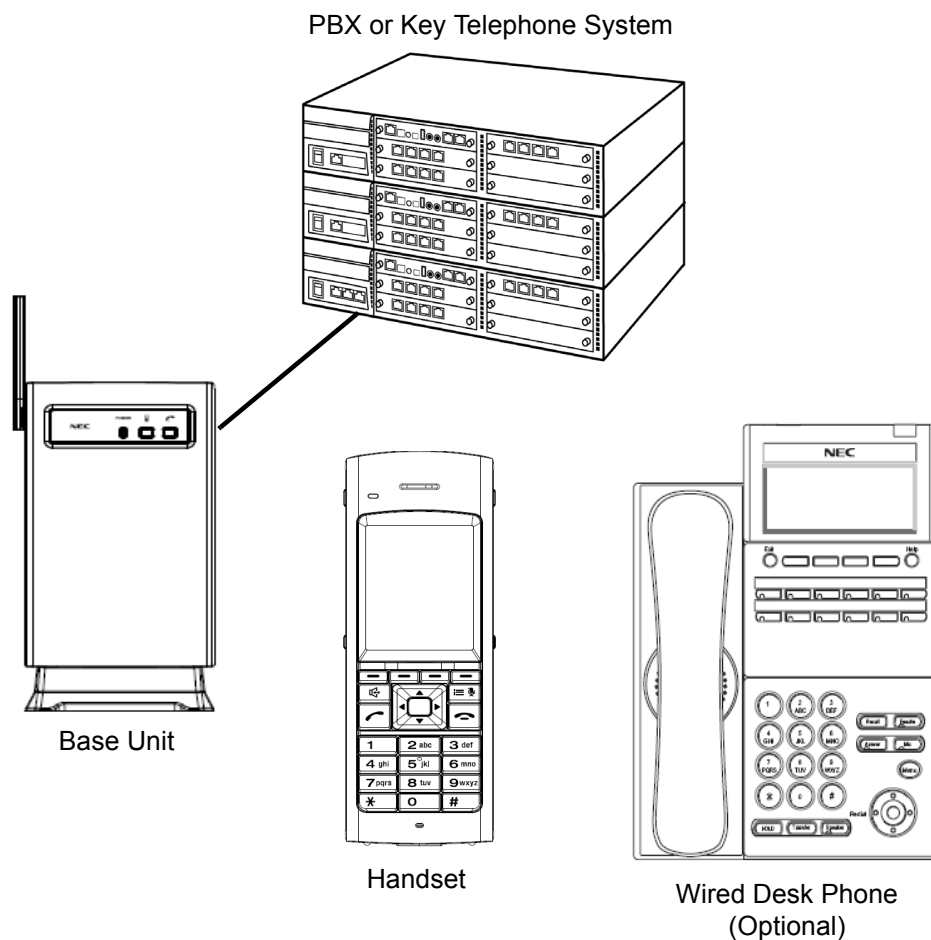



- *The Cordless Handset and wired telephone cannot be used at the same time.*
- *The Handset and Base Station must have the original ID that is written on each unit at the factory.*

SECTION 2 ITEMS INCLUDED WITH THE *D^{term}* CORDLESS DECT

Congratulations on your purchase of the *D^{term}* Cordless DECT. This telephone is designed and engineered to exacting standards for reliability, long life and outstanding performance. To become familiar with the features of the cordless telephone, read this manual thoroughly.

The *D^{term}* Cordless DECT includes the following items:

*Figure 2-2 Items Included with the *D^{term}* Cordless DECT*

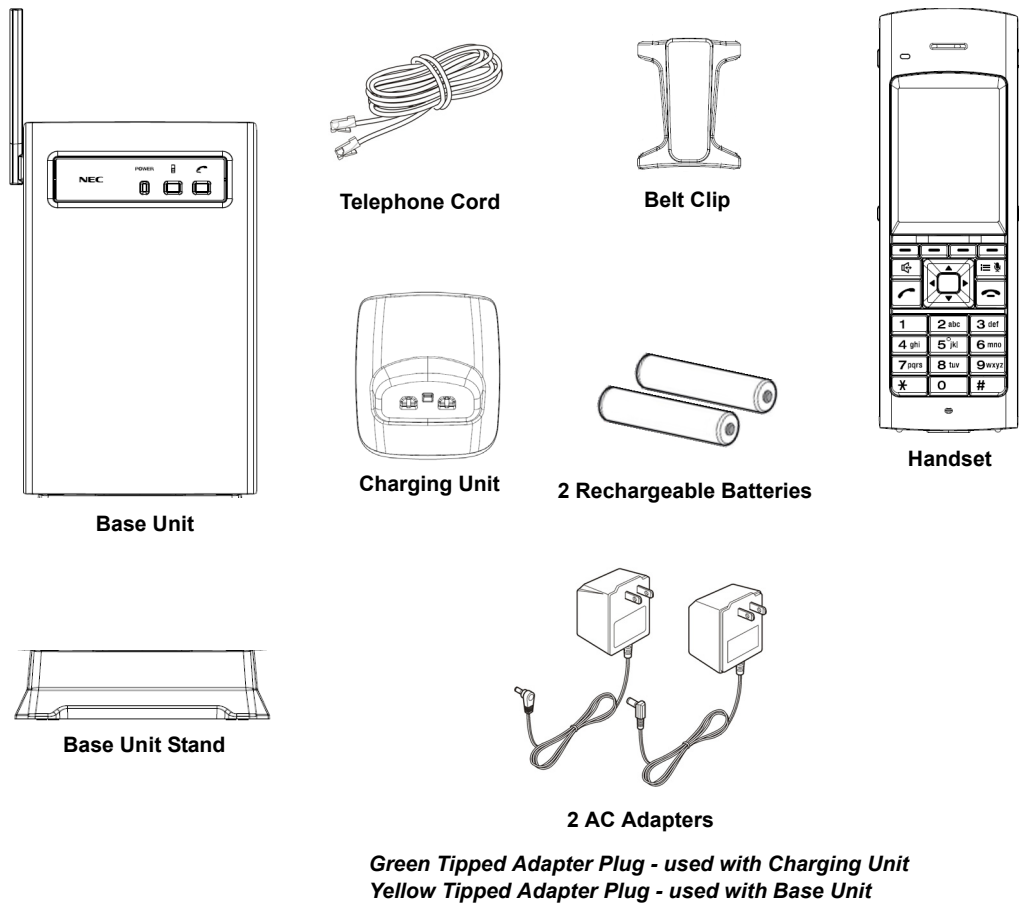

SECTION 3 FEATURES OF THE CORDLESS TELEPHONE

The D^{term} Cordless DECT provides a variety of features. These features are listed below.

- 1.9G (1920~1930 MHz)
- 5 Channels
- Display: 240x320 dots (QVGA)
- 8 Programmable Keys: (Soft Keys)
- Headset Jack
- Mute Control
- AutoStandby[®]
- Handset/Headset/Handsfree Volume Control
- Adjustable Ringer Volume Control
- 6 Selectable Ring Tones
- Vibrating Ringer
- Out of Range Detection and Alarm Tone
- LCD Backlight
- Automatic Channel Selection
- Single Key Access to: Conference, Hold, Transfer and Redial features
- Wall Mountable Separate Charging Unit
- Easy Installation
- Compact Handset Design
- Use with an NEC Digital Multiline Telephone
 - ➔ *On the SV9100, the D^{term} Cordless DECT can be used in conjunction with the DTL and DTZ multiline telephones.*
 - ➔ *With SV9300, the D^{term} Cordless DECT can be used in conjunction with the D^{term}, DTH, DTL and DTZ multiline telephones.*

SECTION 4 D^{term} CONTROLS AND FUNCTIONS

The primary components of the D^{term} Cordless DECT consist of the handset and the base unit. Before using the telephone for the first time, you should become familiar with the controls and functions of the handset and base unit.

4.1 Handset

The handset is used to make/receive calls. The various buttons and LCD provide access to and provide indication of the various functions and operations of the phone. [Figure 2-3 DTZ-8R-1 Handset Controls and Functions on page 2-4](#) provides a layout of various controls and functions available with the handset. For a detailed description of the buttons, refer to [Chapter 4 D^{term} Handset, Base Unit and Charging Unit, Section 1 Handset Controls on page 4-1](#).

Figure 2-3 DTZ-8R-1 Handset Controls and Functions

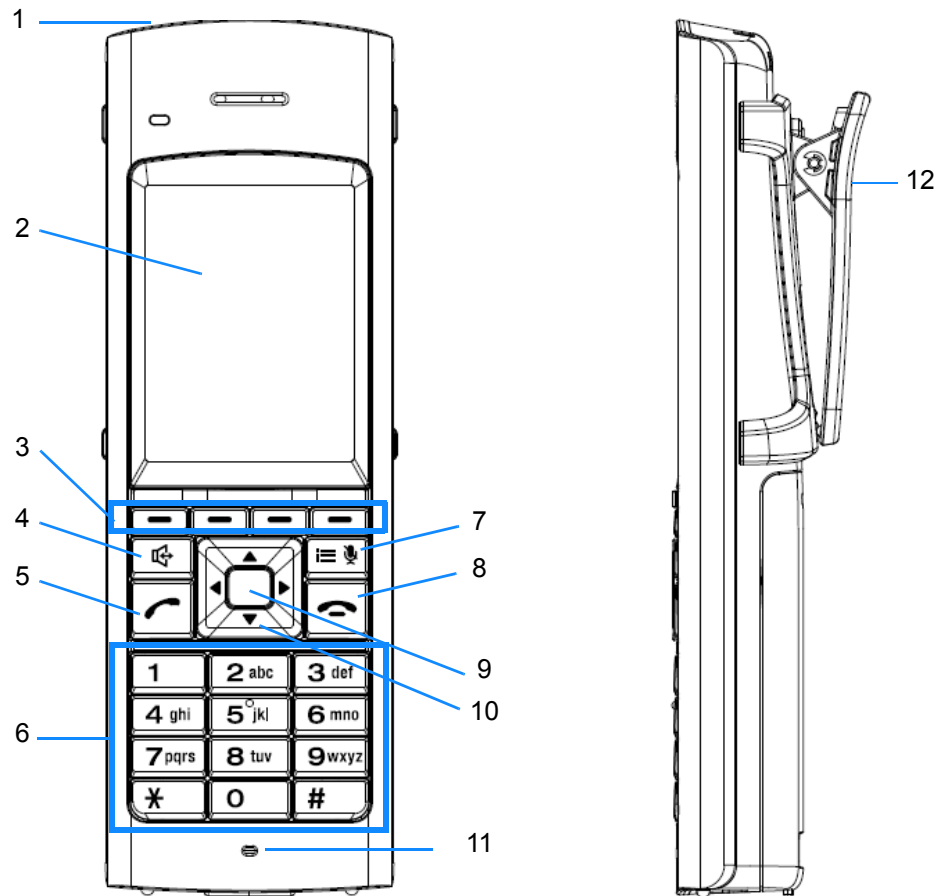

- | | |
|-----------------------------------------------------------------------------------------------------------------------------------------------------------------------------------------------------------------------------------------------------------------------------------|-----------------------------------------------------------------------------------------------------------------------------------------------------------------------------------------------------------------------------------------------------------------------------------|
| <ul style="list-style-type: none"> 1. Headset Jack 2. Message Display 3. Soft Keys (used for HOLD, CONF, TRANSFER, REDIAL, etc.) 4. Handsfree Speaker Key 5. Answer Key 6. Numeric Keypad | <ul style="list-style-type: none"> 7. Mute/Menu Key 8. End Call Key 9. Center Key 10. Handset/Ringer Volume
(Increase ▲ / Decrease ▼)
LCD Contrast
(Increase ► / Decrease ◀) 11. Microphone 12. Belt Clip |
|-----------------------------------------------------------------------------------------------------------------------------------------------------------------------------------------------------------------------------------------------------------------------------------|-----------------------------------------------------------------------------------------------------------------------------------------------------------------------------------------------------------------------------------------------------------------------------------|

4.2 Base Unit

The Base Unit allows users to switch between the *D^{term}* Cordless DECT phone and the wired (desk) phone by using the Desk/Cordless buttons on the unit.

Figure 2-4 Base Unit Controls and Functions

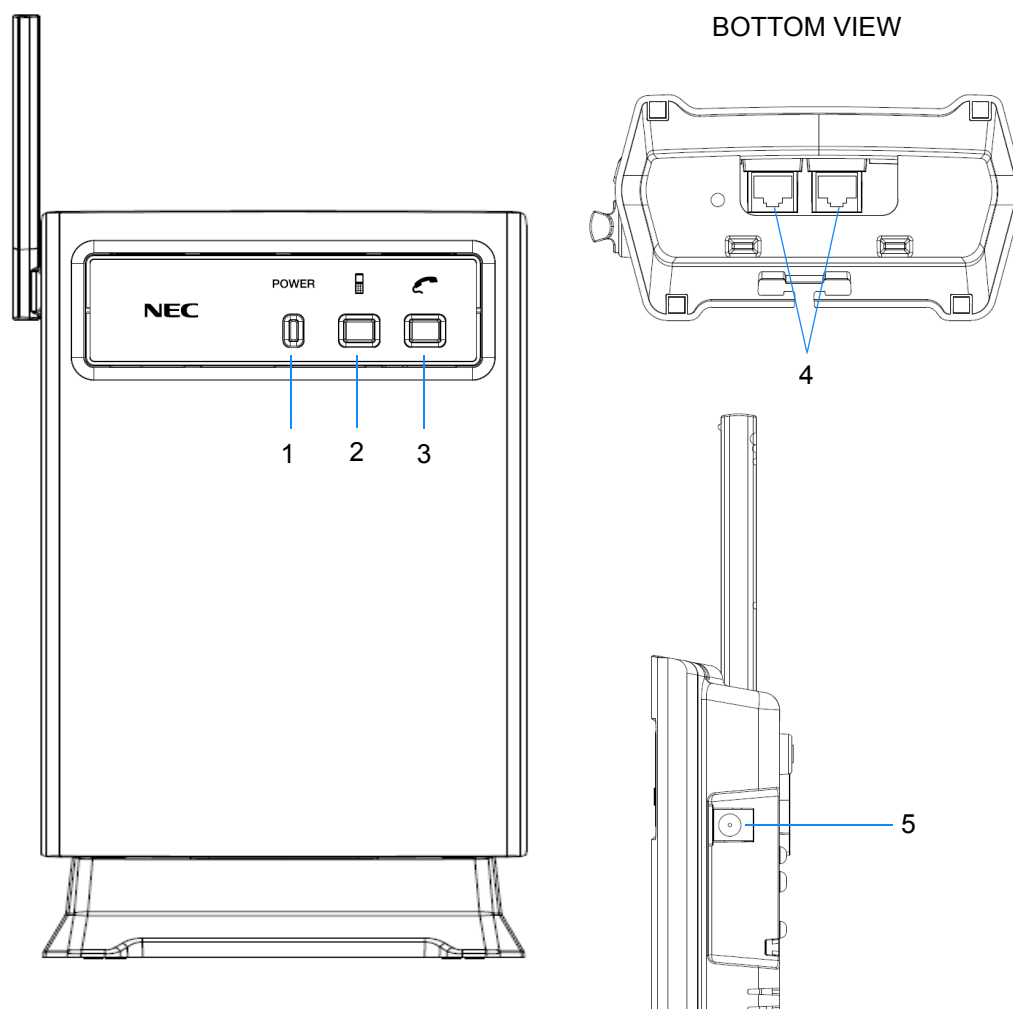

- | | |
|--------------------|------------------|
| 1. Power LED | 4. Modular Jacks |
| 2. Cordless Button | 5. Power Jack |
| 3. Desk Button | |

4.3 Cordless Handset/Desk Phone Switch (Base Key Option)

It is possible to select between cordless handset operation and desk phone operation using the cordless handset. To enable this feature, the Base Key Option setting must be set to On. (Base Key Option is set to Off by default.)

To enter the Base Key Option setting:

1. Press the **Mute/Menu** key followed by **1, 2, 3, #** on the numeric keypad.
2. Scroll down to the **Base Key Option** setting and select **On**.
3. With Base Key Option set to On, press the **Center** key. The Desk and H/S soft keys should be displayed.
4. Select **Desk** for desk phone operation.
5. Select **H/S** for cordless handset operation.

4.4 Charging Unit

The Charging Unit is used to recharge the batteries in the handset.

Figure 2-5 Charging Unit

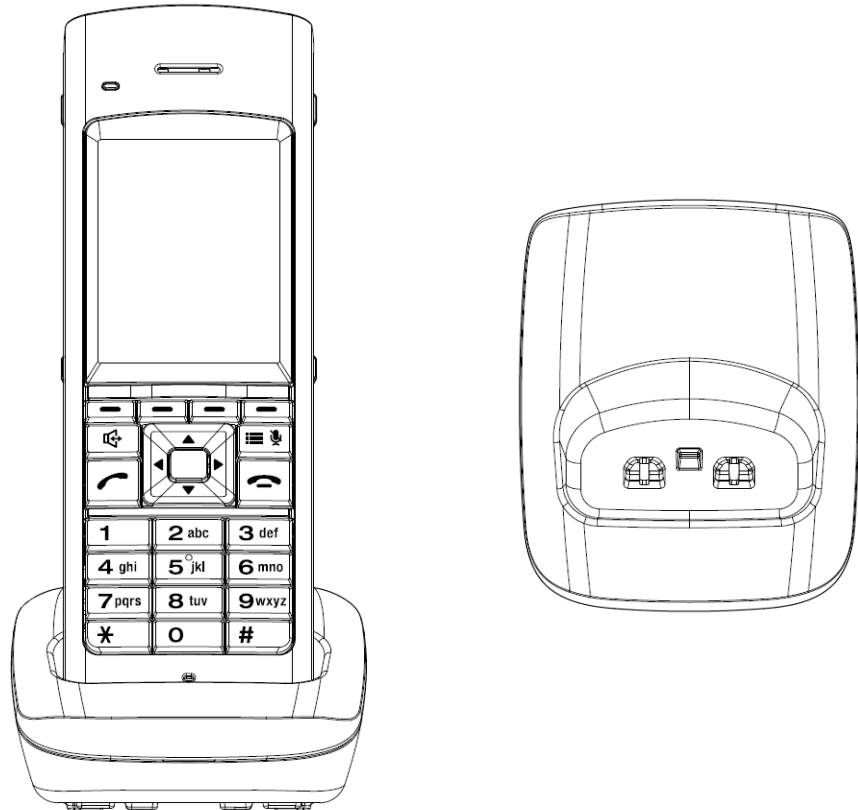



SECTION 1 SELECTING A LOCATION

Select a location for the D^{term} Cordless DECT to avoid excessive heat or humidity. The base unit of the D^{term} Cordless DECT can be placed on a desk or tabletop near a standard 120 Vac outlet and telephone line jack. The base unit can also be mounted on a standard wall plate using the wall mount adapter. Keep the base unit and handset away from sources of electrical noise (motors, fluorescent lighting, computers, PC monitor). Refer to [Chapter 1 Specifications and Safety Information](#) for a complete discussion of safety precautions.

SECTION 2 INSTALLATION PRECAUTIONS

To ensure optimum performance follow these guidelines.

- Each base unit must be placed at least 20 feet (6m) apart.
- Always place the base unit on top of a desk or on higher shelves. Avoid locations surrounded by metal surfaces.
- Place the base unit away from any electrical component such as a PC, monitor and other telephone.

SECTION 3 CONNECTING THE TELEPHONE CORDS

When connecting the telephone cords, observe the following precautions.

- Never install telephone wiring during a lightning storm.
- Never touch bare telephone wires or terminals unless the telephone line has been disconnected at the network interface.
- Use caution when installing or modifying telephone lines.

To connect the telephone cords:

1. Connect one line cord from NEC's PBX (or key system) digital station port to the Line In connector on the *D^{term}* Cordless DECT base unit. Connect another line cord from the Line Out connector to a qualified *D^{term}* multiline telephone.

Figure 3-1 Connecting Telephone Cords

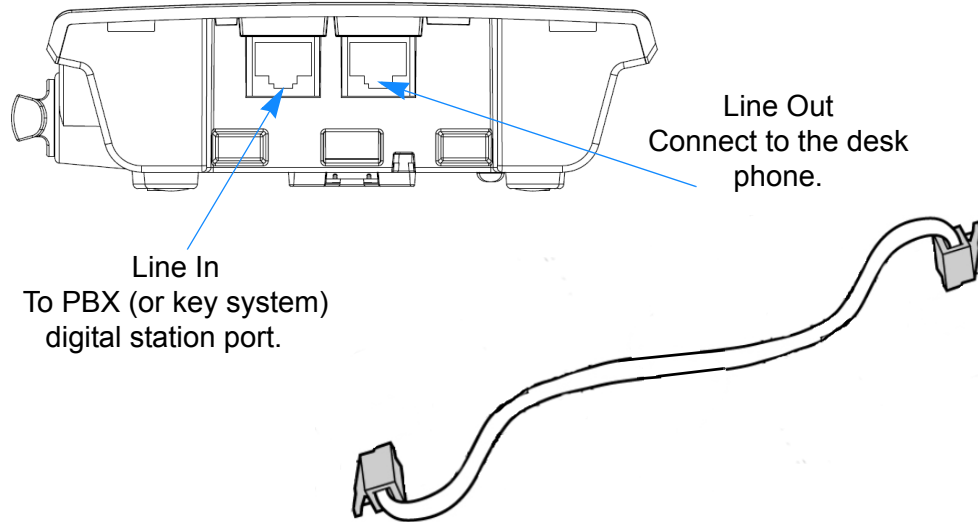

NOTE

Do not connect the DTZ-8R-1 line cord directly to PBX station card as the DTZ-8R-1 will not function. Connect the line cord to the jack with a single pair connected back to one digital station port.

SECTION 4 APPLYING POWER TO THE CHARGING UNIT

The unique design of the telephone allows the user to place the handset in the charging unit with or without the belt clip attached.

Connect the AC adapter with the green tip to the charging unit and to a suitable AC power source.

Figure 3-2 Applying Power to the Charging Unit

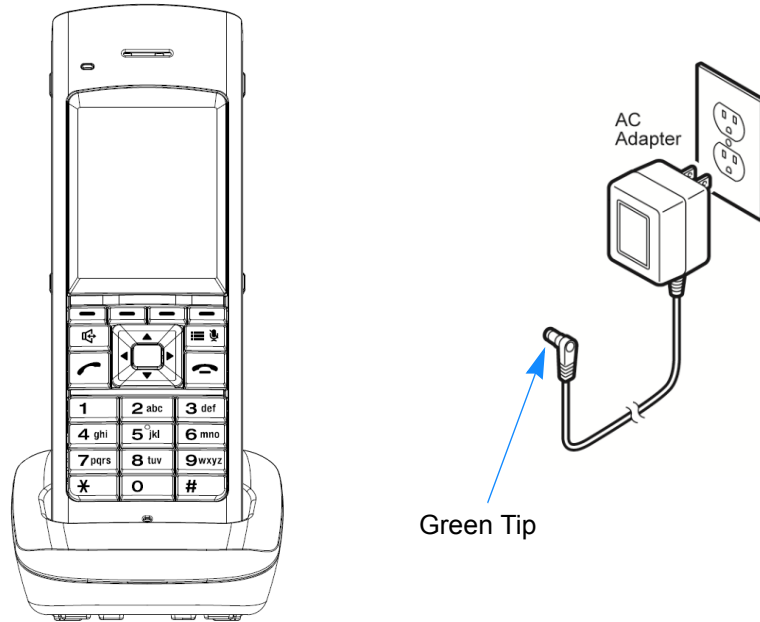

Use only the supplied AC adapter for the charging unit.



Route the power cord where it will not create a trip hazard, or where it could become chafed and create a fire or other electrical hazards.

SECTION 5 WALL INSTALLATION

 **IMPORTANT** — *The DTZ-8R-1 does not support wall plate mounting.*

5.1 Mounting the Base Directly to the Wall

Before mounting the telephone, consider the following:

- Select a location away from electrical cables, pipes, or other items behind the mounting location that could cause a hazard when inserting screws into the wall.
 - *The location must be near a 120Vac power outlet so that the AC power adapter can reach.*
 - *Also consider proximity to the PBX (key system) so that the telephone line cord will not be excessively long.*
- Make sure the wall material is capable of supporting the weight of the base unit.
- Use #10 screws with anchoring devices suitable for the wall material where the base unit will be placed.

To mount the telephone:

1. Insert two mounting screws 3-15/16" apart. Allow 3/16" between the wall and screw heads for mounting the telephone.

Figure 3-3 Inserting Screws into the Wall for Wall Mounting the Telephone

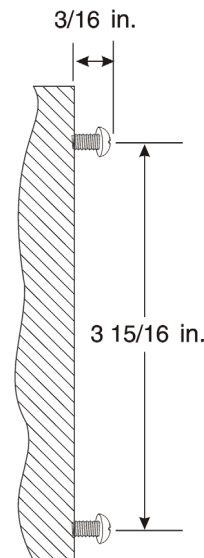

2. Plug the AC adapter (yellow tip) into the base unit, and route the cord through the molded channel on the back of the base unit.
3. Plug one end of the short telephone cord (locally supplied) into the **LINE** jack on the base unit. If the NEC multiline (wired) phone is used, connect a line cord from the **LINE OUT** jack on the base unit to the multiline phone.
4. Place the base unit on the posts of the wall screws and push down until it is firmly seated.

Figure 3-4 Attaching the Base Directly to the Wall

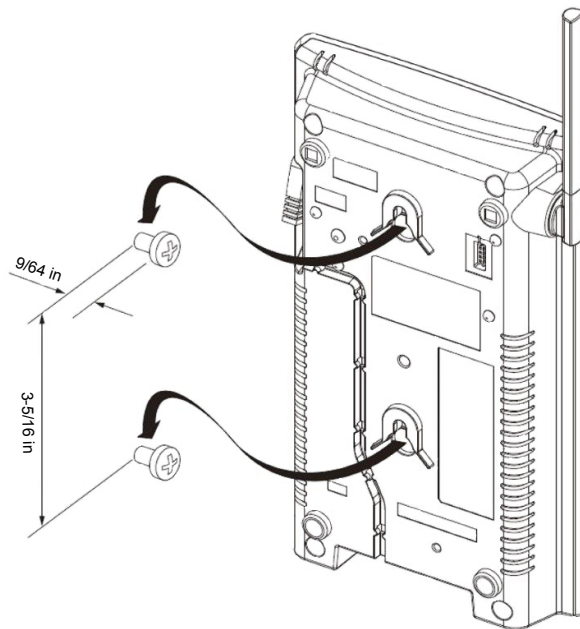

5. Plug the other end of the short telephone cord into the telephone wall jack.
6. Plug the AC adapter into a standard 120 VAC wall outlet.



Do not use an outlet controlled by a wall switch.

SECTION 6 ATTACHING AND REMOVING THE BELT CLIP

A belt clip can be used to attach the handset to a belt or pocket for convenient portability.

1. Slide the clip into the tab slots. Press firmly until it snaps into place. The belt clip is designed to fit snugly onto the handset.

Figure 3-5 Attaching the Belt Clip to the Handset

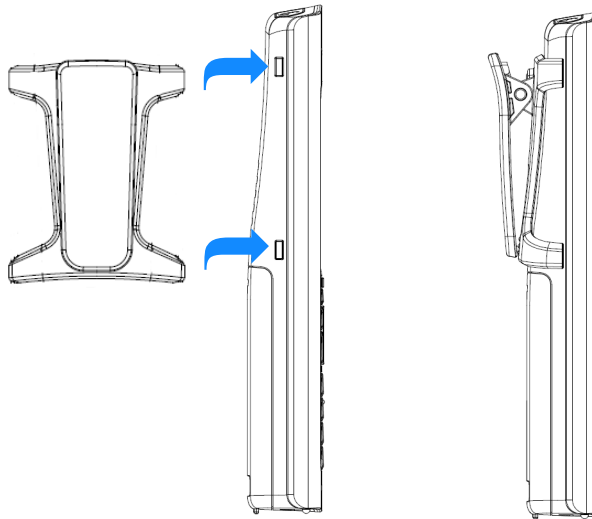

2. To remove the clip, press the retaining clip in toward the belt clip blade and slide the clip up at the same time.

Figure 3-6 Removing the Belt Clip

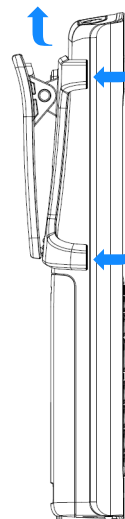

SECTION 7 INSTALLING THE HANDSET BATTERIES

Before installing batteries, refer to [Chapter 1 Specifications and Safety Information, Section 3 Battery Safety on page 1-4](#). It is important to follow safety regulations when handling batteries.

1. Remove the battery cover by pressing the latch and sliding the cover down and off of the handset.

Figure 3-7 Removing the Battery Cover

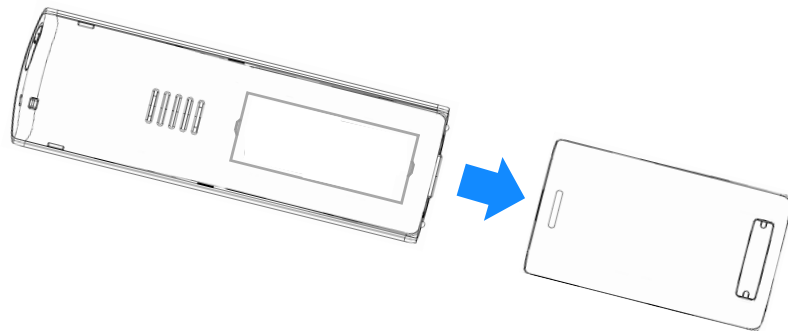

2. Install the two AAA batteries (AAA Ni-MH, 1.2V, 900mAh re-chargeable batteries), observing the polarity orientation.



Batteries must be the same size and type (AAA Ni-MH, 1.2V, 900mAh re-chargeable batteries). Use of other battery types may be hazardous and will void the product warranty.

Figure 3-8 Installing the Batteries

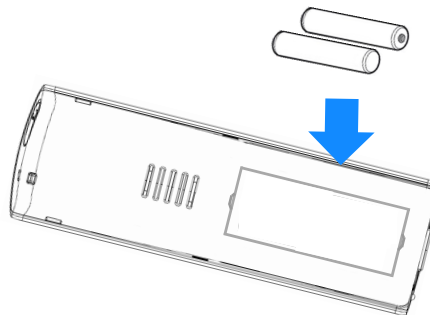

3. Replace the cover and slide it up until it latches onto the handset.

Figure 3-9 Replacing the Battery Cover

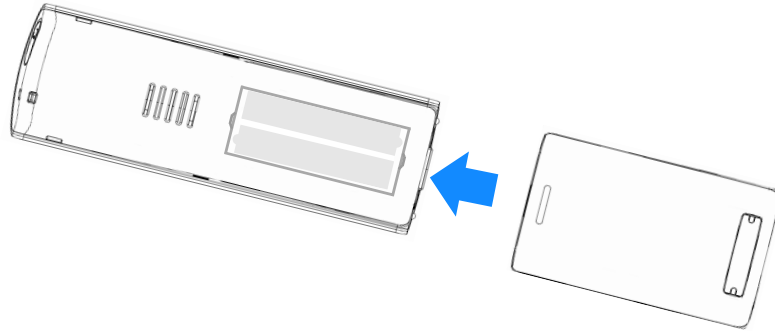

SECTION 8 CHARGING BATTERIES

8.1 Charging the Handset Batteries

The rechargeable batteries must be fully charged before using the handset for the first time.



Charge the batteries without interruption for at least 10 hours.

IMPORTANT

1. Place the handset in the charging unit.
2. Make sure the **Handset Charging** LED indicator lights. If the **Handset Charging** LED does not come on, check to see if the AC adapter is plugged in and that the handset is making good contact with the charging contacts on the charging unit.



*The **Handset Charging** LED turns blue during and after charging the handset with the battery.*

NOTE

Figure 3-10 Handset Charging LED Indicator

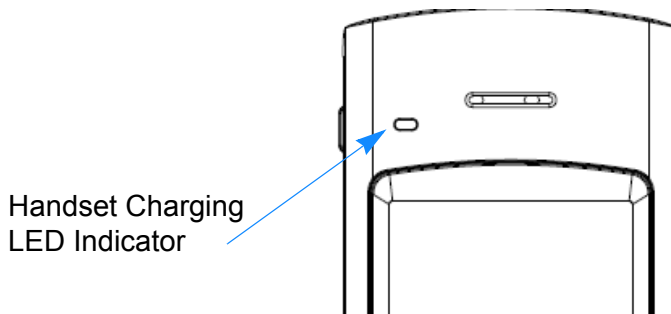

SECTION 9 LOW BATTERY INDICATOR

9.1 Low Battery

The handset has visual and audible indicators to warn of a low battery condition.

Figure 3-11 Low Battery Indicator



In Standby Mode

The Battery Status icon in the LCD changes to battery low. The “Charge Battery” message blinks on the LCD (ON: 600msec, OFF: 600msec).

In Talk Mode

The Battery Status icon in the LCD changes to battery low. The Handset remains in Talk Mode and the battery low alert tone is emitted every 30 seconds.

In Other Mode (Excluding Standby Mode and Talk Mode)

The Battery Status icon in the LCD changes to battery low.

9.2 Battery Status

The LCD shows the battery charge status according to the remainder capacity of the battery.

(Warning) Non Rechargeble Battery	(Full) 100-67%	(Level 3) 66-34%	(Level 2) 33-10%	(Low) 9-0%

When you receive the low battery indication, return the handset to the charger unit for charging.

The following table indicates what occurs and the action to be taken during a call or in Standby Mode when low battery indication is displayed.

On a Call	In Standby Mode
What occurs when Battery icon message blinks:	
Handset beeps once every 30 seconds	Charge Battery message blinks
Action:	
Complete the call as quickly as possible	Return the handset to the charger unit.
Return to charger.	

SECTION 10 CLEANING THE BATTERY CHARGING CONTACTS

To maintain a good charge, it is important to clean all charging contacts on the handset and charging unit about once a month. Use a pencil eraser or other contact cleaner. Do not use liquids or solvents.

Figure 3-12 Cleaning Battery Charging Unit Contacts

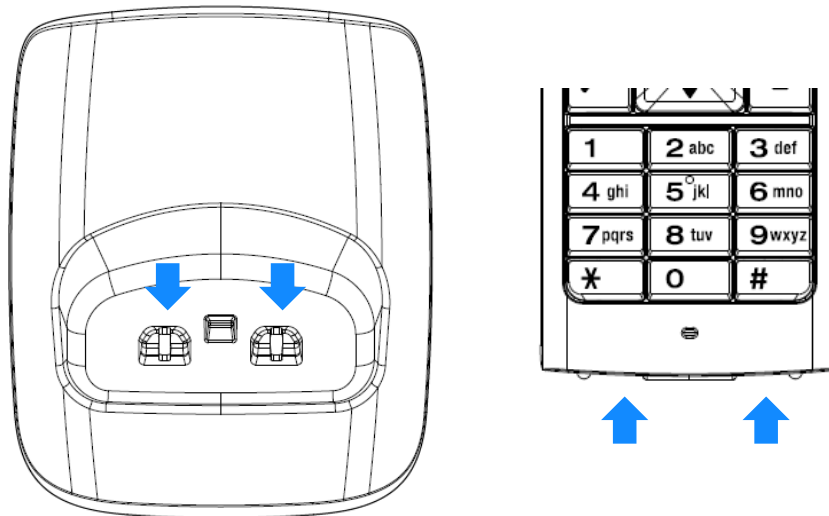

SECTION 1 HANDSET CONTROLS

The operations of the *D^{term}* are performed using the handset. The **HOLD**, **CONF** (conference), **TRANS** (transfer), **REDIAL**, **TALK**, **MUTE** and ringer volume are located on the handset and are used to control various functions.

Refer to [Figure 4-1 Handset Controls](#) for a diagram of the Handset controls and to [Table 4-1 Handset Control Functions on page 4-2](#) for an explanation of the handset controls.

Figure 4-1 Handset Controls

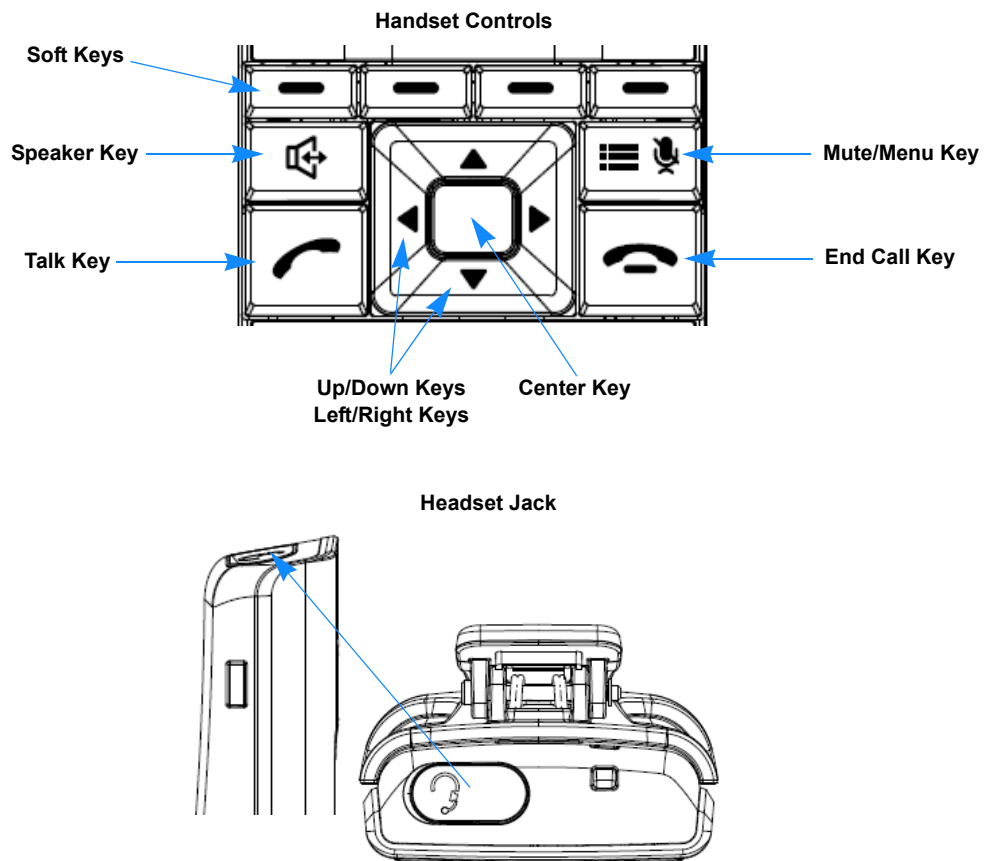

Handset Controls

Table 4-1 Handset Control Functions







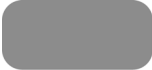

Condition	Action
 HOLD	Press HOLD on the front of the handset to place an existing call on hold.
 CONF	Press CONF on the front of the handset to add a call to a conference.
 TRANS	Press TRANS on the front of the handset to transfer a call.
 REDIAL	Press REDIAL on the front of the handset to dial the number that was previously dialed. <input type="checkbox"/> Up to 32 digits
	Press the Talk key to make a call. The telephone first acquires a connection to the base. Press the End Call key to end a call.
	Press Mute/Menu key located on front of the handset, to mute a conversation. Press this button again to resume the conversation. During a conversation, this button is used to toggle the microphone function on and off. When the conversation ends, muting is turned off. In Standby mode, press the Mute/Menu key to display the user menu window.
	Press the Speaker key in Standby mode or during Talk mode to turn on Handsfree Talk mode and talk handsfree. For example, Press the Speaker key in Standby mode or Conversation mode to turn on Handsfree Talk mode. When the handset is in Handsfree Talk mode, the Handsfree icon displays on the LCD of the handset. During a conversation you can toggle back and forth between Talk mode and Handsfree Talk mode, press the Speaker key for Handsfree Talk mode or press the Talk key for Talk mode.

Table 4-1 Handset Control Functions (Continued)

Condition	Action
<p>Ringer Volume</p>  <p>VOLUME</p> 	<p>To adjust the ringer volume press the Volume softkey (in Standby mode), then use the Up/Down arrow keys to adjust the ringer volume. You can choose from four different settings:</p> <ul style="list-style-type: none"> <input type="checkbox"/> OFF-Vibrate <input type="checkbox"/> Low <input type="checkbox"/> Medium <input type="checkbox"/> High <p>The LCD displays the current volume setting for two seconds.</p> <p>➤ <i>If Ringer is set to OFF-Vibrate, it will not vibrate when in the charging cradle.</i></p>
<p>Volume</p> 	<p>During a conversation, use the Up/Down arrow keys to adjust the handset receiver volume.</p>
<p>Headset Jack</p>	<p>Insert the Headset plug into the headset jack Use corresponding handset keys to activate headset.</p>

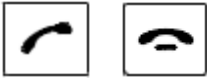
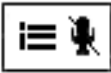
The Base Unit has three LEDs. The operation status of the LEDs are listed below.

Power LED

- Base is powered on: On (Blue LED)
- Base is powered off: Off

Cordless Telephone LED

- Cordless Phone Operation: On
- Desk Phone Operation: Off

Desk Phone LED

- Cordless Phone Operation: Off
- Desk Phone Operation: On

Figure 4-2 Base Unit Controls and Functions

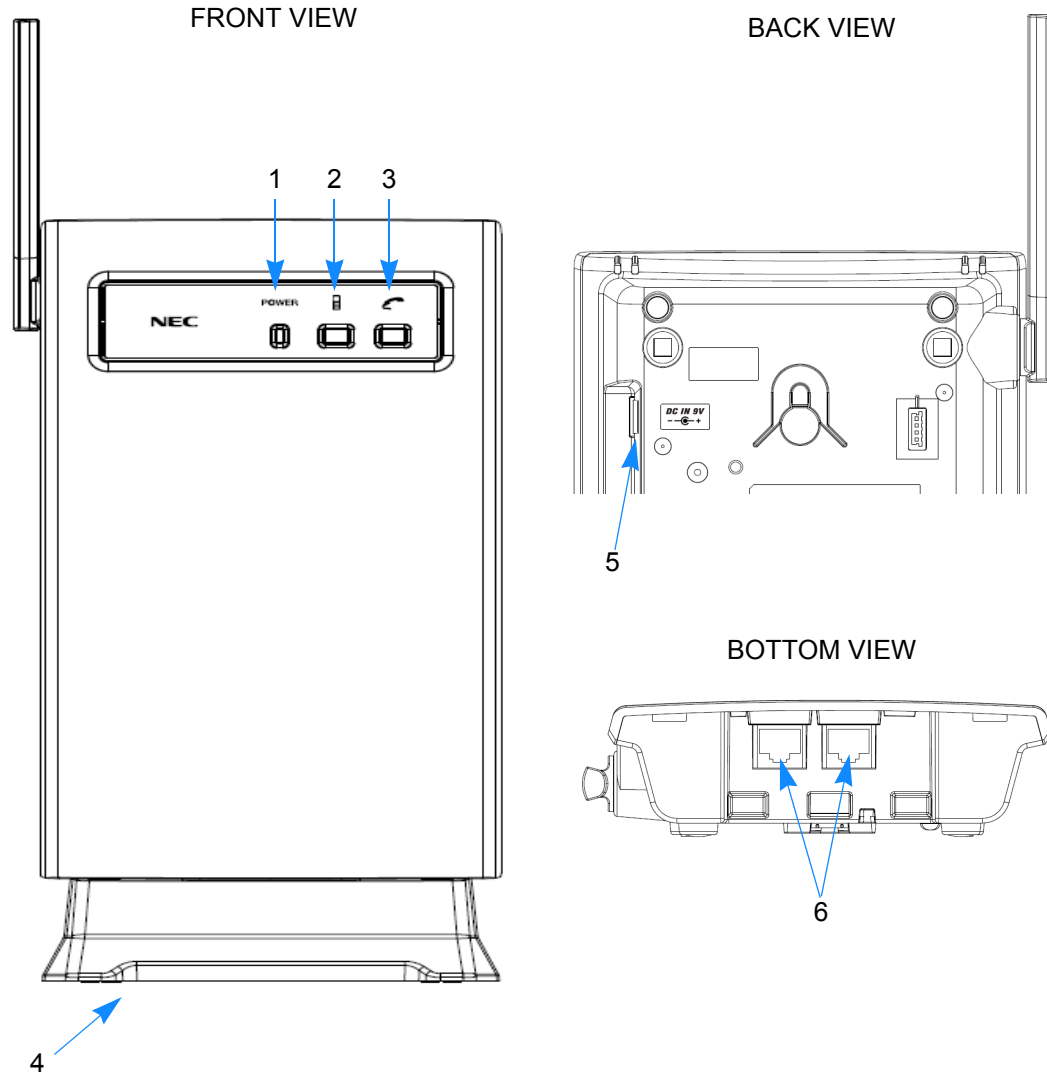

- | | |
|-----------------------------------------|-----------------------|
| 1. Power LED | 4. Stand |
| 2. Cordless Phone Select Button and LED | 5. Power Adapter Jack |
| 3. Desk Phone Select Button and LED | 6. Modular Jacks |

SECTION 1 REPLACEMENT PARTS AND OPTIONAL ACCESSORIES

Optional accessories and replacement parts can be obtained by contacting your NEC representative.

Figure 5-1 Optional Accessories and Replacement Parts

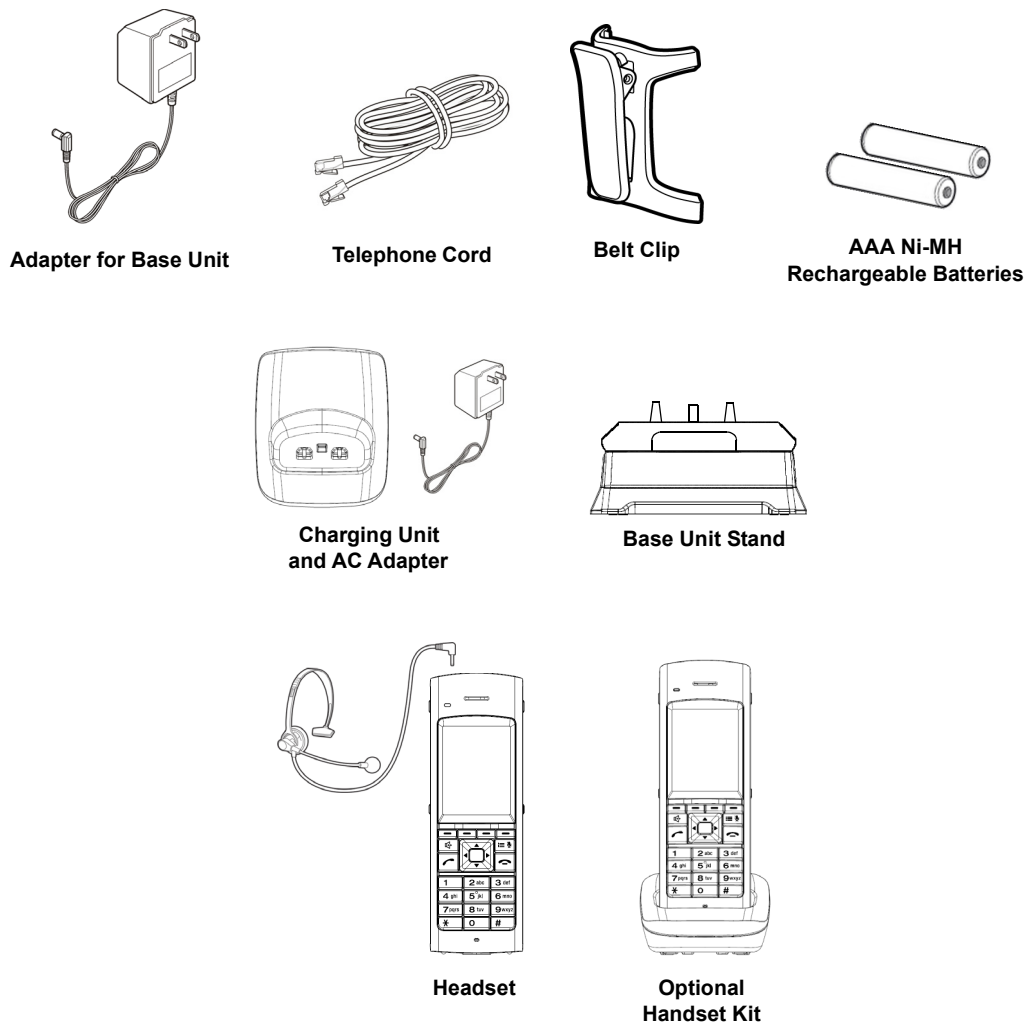

SECTION 2 INSTALLING THE OPTIONAL HEADSET

The optional headset provides a handsfree option for the D^{term} Cordless DECT. With the headset installed, the user can use the belt clip to carry the handset and conduct a conversation using the headset. The second handset must be keyed to operate with the base unit.

To install the headset:

Open the cover over the headset jack and plug the headset into the receptacle.

Figure 5-2 Installing the Headset



No other settings are needed. Operation of the headset is the same as the handset. However, the user hears through the headset earphone and talks through the headset microphone. The handset earphone and microphone (mouthpiece) are disconnected.

➡ *Talk or Speaker key will be used to activate the headset.*

SECTION 1 SETTING UP AND PROGRAMMING THE DTZ-8R-1

 **IMPORTANT** — *The screens in this section are system-dependent and may not match your handset.*

1.1 Programming Mode

1.1.1 Training Mode (Entry)

To enter Training mode:

Press and hold * and # at the same time and then press the **TALK** key. The handset emits a confirmation tone and enters Training mode. The following message is displayed on the LCD and the F1 LED blinks.

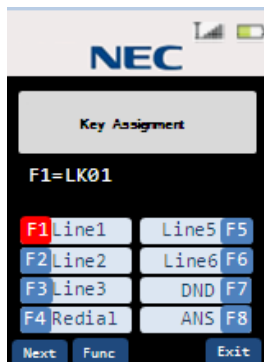

1.1.2 Training Mode (Next Key [Softkey1] – Select Item)

To *select* an item:

Press the **Next** key.

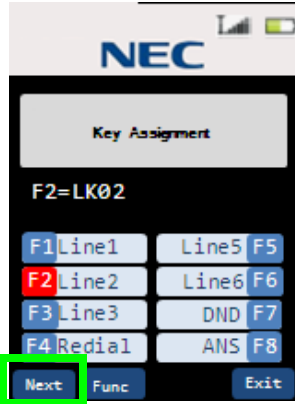

The items in the display change in the following sequence:

F1→F1(TALK)→F2→F2(TALK)→F3→F3(TALK)
 F4→F4(TALK)→F5→F5(TALK)→F6→F6(TALK)
 F7→F7(TALK)→F8→F8(TALK)→OFF HOOK
 RING→F1...

1.1.3 Training Mode (Func Key [Softkey2] – Change Item)

To *change* an item:

Press the **Func** key.

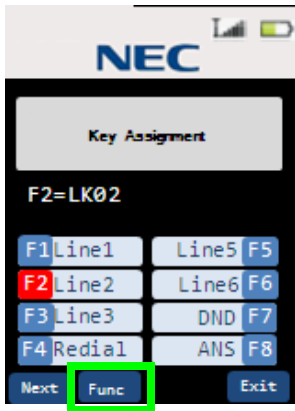

The items in the display change in the following sequence:

LK01→LK02→LK03→LK04→LK05→LK06→
 LK07→LK08→LK09→LK10→LK11→LK12→LK13
 LK14→LK15→LK16→LNRSPD→Recall→FNC→
 ANS→LK01...

1.1.4 Training Mode (Back Key [Softkey4] – Exit from Training Mode)

When the **Back** key is pressed while in Training mode, a key touch tone is emitted and a 'Training off' command is sent to the PBX. The handset exits Training mode.

1.1.5 Training Mode (Volume Up Key – Change Each Item Setting)

The **up** key can change each item setting as illustrated in the following displays (e.g., when the **F1** setting is changed, the F1 LED blinks).

F: 1:= L: K: 0: 1:

▼ press up key

F: 1:= L: K: 0: 2:

▼ press up key

F: 1:= L: K: 0: 3:

▼ press up key

F: 1:= L: K: 0: 4:

▼ press up key

F: 1:= L: K: 0: 5:

▼ press up key

F: 1:= L: K: 0: 6:

▼ press up key

F: 1:= L: K: 0: 7:

▼ press up key

F: 1:= L: K: 0: 8:

▼ press up key

F: 1:= L: K: 0: 9:

▼ press up key

Continued on next page ➡

F 1	=	L	K	1	0					

[▼] press up key

F 1	=	L	K	1	1					

[▼] press up key

F 1	=	L	K	1	2					

[▼] press up key

F 1	=	L	K	1	3					

[▼] press up key

F 1	=	L	K	1	4					

[▼] press up key

F 1	=	L	K	1	5					

[▼] press up key

F 1	=	L	K	1	6					

[▼] press up key

F 1	=	L	N	R	/	S	P	D		

[▼] press up key

F 1	=	R	e	c	a					

[▼] press up key

Continued on next page ➡

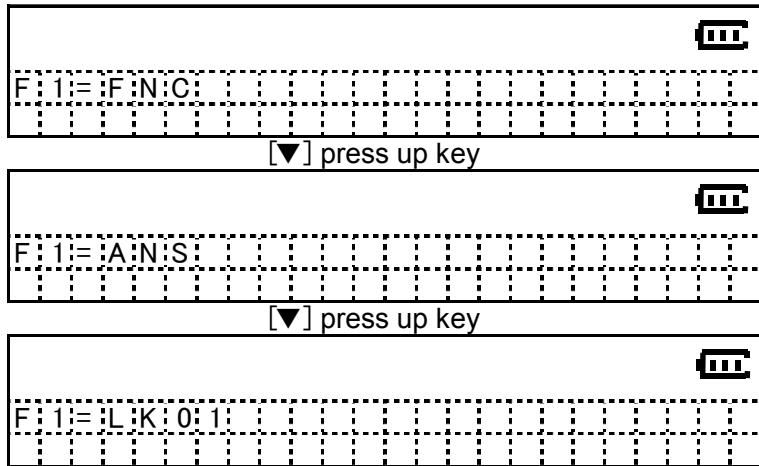

SECTION 2 HANDSET OPERATION

This operation is one of the examples for the DTZ-8R-1 with an NEC PBX. As a result, it might be different from actual operation on your system. Operation of DTZ-8R-1 in digital mode depends on each PBX specification.



IMPORTANT

- *The screens in this section are system-dependent and may not match your handset.*
- *Depending on the system the handset may not follow automatic idle return.*

2.1 Switching Between the Wired Phone and Cordless Phone (DTZ-8R-1 Handset)

Press the **Base Left** key to change to the cordless phone (DTZ-8R-1 Handset). When the cordless phone is selected, there is no message on the LCD. Press the **Base Right** key to change to the wired phone. When the wired phone is selected, the LCD shows 'DESK TEL'.

Base Left Key

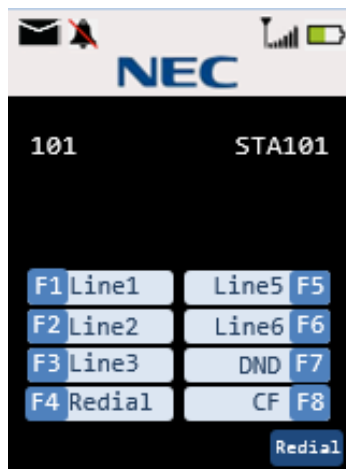

Base Right Key



2.2 Making a Call to Another Extension

To make a call to another extension:

1. Press the **TALK** key on the handset. The handset tries to connect to the base station while the “ACQUIRING LINK” message blinks on the LCD.



2. When connected, the handset goes into Talk mode and the Talk icon is turned on and displays the current volume.

Talk Key



Speaker Key



- 3. If the user dials 1,2, 3 the LCD displays the dialed number as they are pressed.

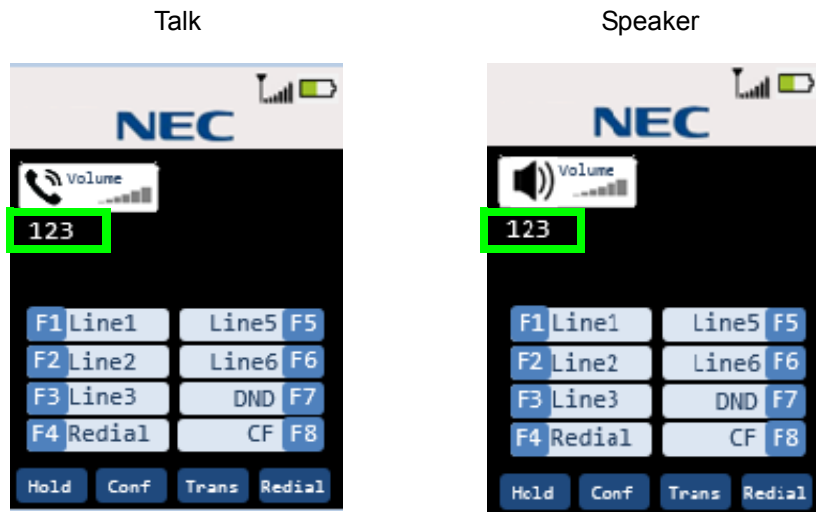

- ➔ When Base Station is not connected to a PBX, the handset displays "DISCONNECT".

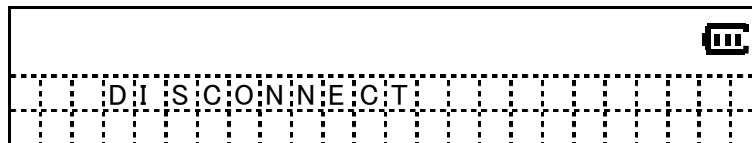

- ➔ When the handset cannot connect to the base station, an error tone is emitted and "Out of Range" is displayed for five seconds on the LCD and the handset goes into Standby mode.

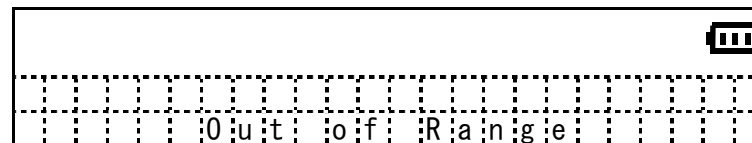

- ➔ The handset cannot go into Talk mode when the wired phone is selected.

- 4. The LCD displays the message, indicating the call is taking place.

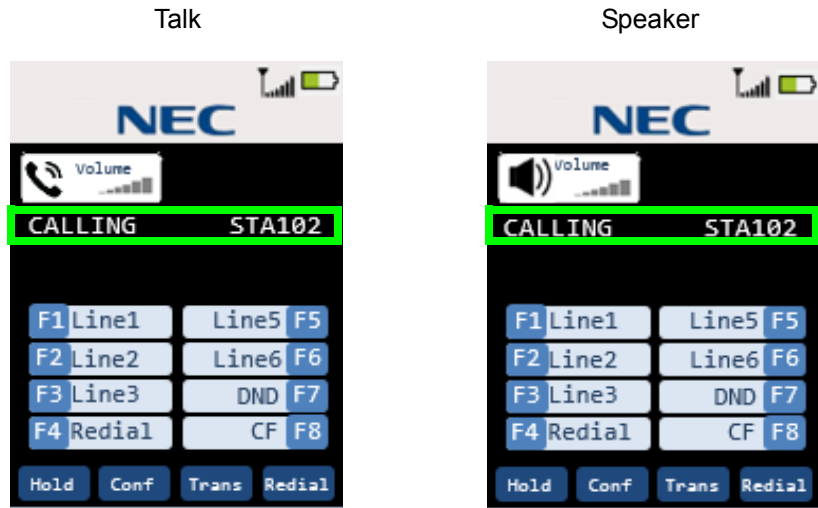

- 5. When the called party answers, the LCD displays a message to indicate the phone is in Talk mode.

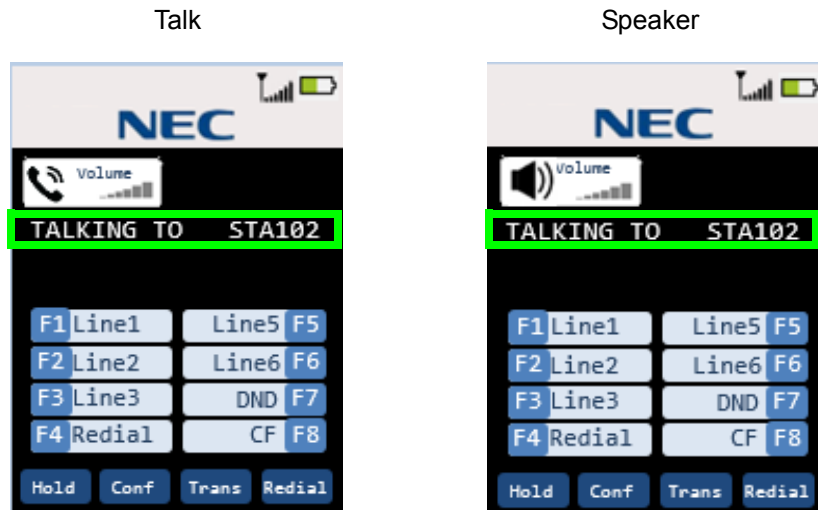

2.2.1 Connection Considerations

1. When the base station is not connected to the PBX, the handset displays “DISCONNECT”.

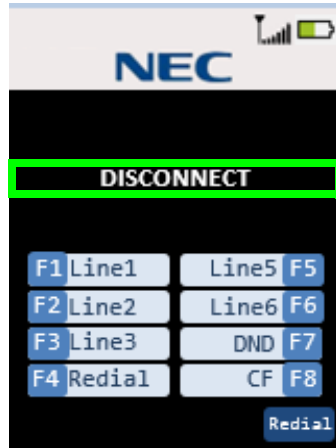

2. When the handset does not connect to the base station, an error tone is emitted and “Out of Range” message is displayed for five seconds. The handset then goes to standby mode.

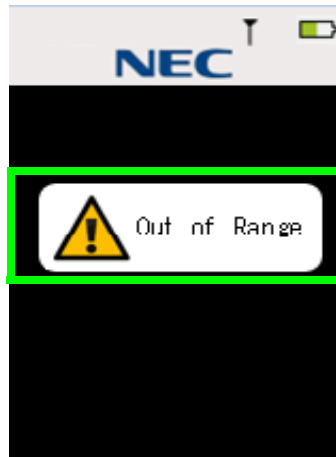

3. When a desktop (wired) phone is selected, the handset does not go into Talk mode.

2.3 Retrieving a Call to Another Extension

To retrieve a call from another extension:

1. When an incoming call is received from another extension, the handset goes into Incoming Call mode. The display indicates there is an incoming call.



IMPORTANT

- Answering a call on the secondary line will differ depending on the system.
- Press the center key and use the down arrow to select the ringing line. Press the center key again to answer the call.



2. If you press either the **Talk** or dial pad keys (0~9, *, #) or pick the handset from the cradle, the handset connects to the base station and “ACQUIRING LINK” displays.

➔ *If the connection is established quickly, the message “ACQUIRING LINK” may not display.*



- Once the handset connects to the base station, the **Talk** icon and the volume indicator display. After you answer the call, the station number of the calling party displays.



2.4 Making Call to Outside Line

To make an external call:

- Press the **Select** key on the handset and select **F1**. The handset establishes an RF connection with the base station. The LCD display does not change.



IMPORTANT

- *Making a call on the secondary line will differ depending on the system.*
- *Press the center key and use the down arrow to select the desired line. Press the center key to hear dial tone and then make the call.*

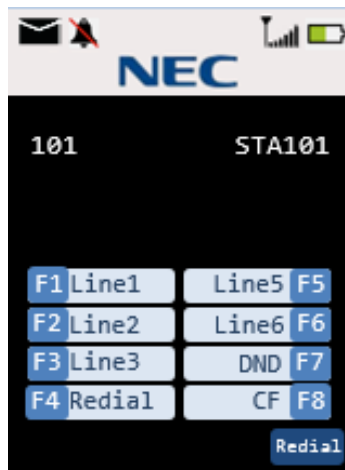

- 2. When the RF connection is established, the handset goes into Talk mode and the Talk icon and the volume indicator display. The F1 LED also lights.



- ➔ When the outside line is not connected with the PBX, "HANG UP" is displayed and you hear a busy tone.

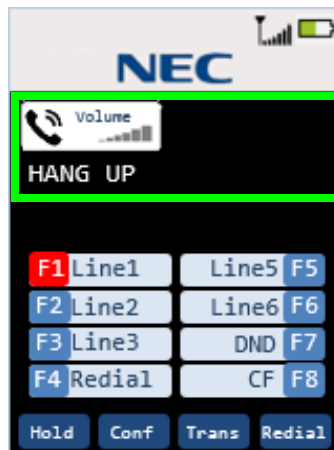

- If the user dials 1,2, 3 the LCD displays the dialed number as they are pressed.

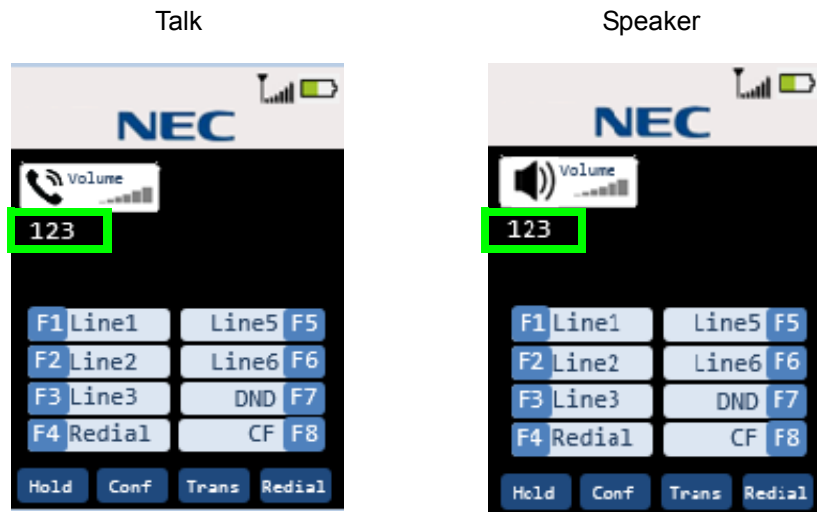

2.5 Receiving a Call from an Outside Line (Depends on PBX Line)

To receive a call from an external line:

- When you receive an incoming external call, the F1 LED blinks.

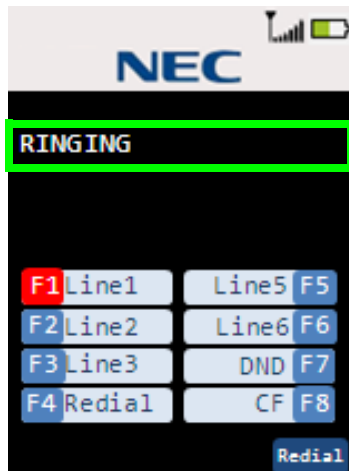

2. If you press either the **Talk** or dial pad keys (0~9, *, #) or pick the handset from the cradle, the handset connects to the base station and “ACQUIRING LINK” displays.
 - ➔ *If you press the F1 (select key → up/down → select key), the handset connects to the base station. However, “ACQUIRING LINK” is not displayed.*



3. When the RF connection is established, the handset goes into Talk mode and the Talk icon and the volume indicator display.



2.6 Redial (Option)

When the RF link is established between the handset and the base station, you can press the **REDIAL** key. The last number dialed is shown and the digits dialed are sent to the base station.



NOTE

- *An error tone is emitted when redial is empty.*
- *Dial limit is 32 digits, redial stores up to 32 digits in memory.*
- *Redial data is stored in handset memory (EEPROM).*
- *If **F1~F12** keys are pressed, the number dialed before the Function key is pressed will be stored in redial memory.*

Example:

(1) [talk][1][2][3][talk] redial: 123

(2) [talk][1][2][3].....[1][2][talk] (over 32 digits) redial: 123.....12
(up to 32 digits)

(3) [talk][1][2][3][F1][4][5][6][talk] redial: 123

2.7 AutoStandby®

When the handset is in one of the modes listed below, placing the handset on the charger changes it to Standby mode. At this time, a confirmation tone is emitted.

- Ringer Volume Setting
- Menu Setting
- Talk Mode
- Trying to Connect to the Base Station

2.8 PBX No Service

When the base station is linked to a wired telephone and you press the **TALK** or **Speaker** key, there is know acknowledgment from the PBX.

The handset goes into Standby mode and the LCD displays “ACQUIRING LINK”.



The handset does not emit a tone when it goes into Standby mode.

2.9 Out Of Range

When in Standby Mode

The handset displays the message “Searching” when the handset cannot find the base station (Out of Range) in Standby mode.

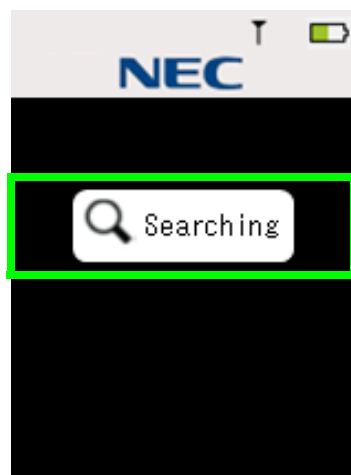

When Establishing an RF Link

If the **TALK** or **Speaker** key is pressed but the handset cannot establish an RF Link with the base station, the handset emits an error tone and displays the message “Out of Range”.

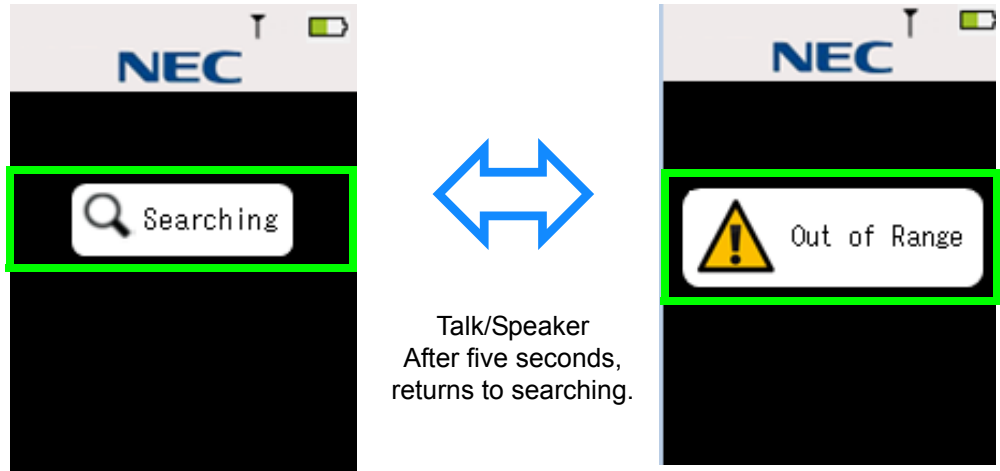

While Talking

If the handset cannot receive a signal from the base station in about five seconds, it goes to Standby mode and emits an error tone. In this case, the LCD displays “Out of Range”.

If the base cannot receive a signal from the handset in about five seconds, it goes to Standby mode.

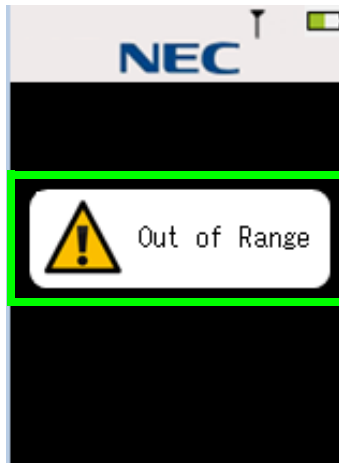

2.10 Low Battery

The handset has visual and audible indicators to warn of a low battery condition.

In Standby Mode

The Battery Status icon in the LCD changes to battery low.
The “Charge Battery” message blinks on the LCD (ON: 600msec, OFF: 600msec).

In Talk Mode

The Battery Status icon in the LCD changes to battery low.
The handset remains in Talk mode and the battery low alert tone is emitted every 30 seconds.

In Other Mode (Excluding Standby Mode and Talk Mode)

The Battery Status icon in the LCD changes to battery low.

2.11 Battery Status

The LCD indicates the battery capacity as indicated in the diagram below.

(Warning) Non Rechargeable Battery	(Full) 100-67%	(Level 3) 66-34%	(Level 2) 33-10%	(Low) 9-0%

2.12 Mute

Press the **Menu/Mute** key in Talk mode. The Mute icon is on and the sound from the microphone is muted.

Press **Menu/Mute** again to cancel mute. The Mute icon is off.

➡ *Finishing Talk mode also cancels mute.*

2.13 Handsfree

Press the **Speaker** key in Standby mode or during Talk mode. The handset switches to Handsfree Talk mode. The Handsfree icon is on.

Press the **TALK** key in Handsfree Talk mode. The Handsfree icon turns off. The handset switches to Talk mode.

Press the **Speaker** key in Handsfree Talk mode. The handset cancels Talk mode and switches to Standby mode.

2.14 Headset

To put the handset into Headset mode:

Insert the headset plug in headset jack while in Talk mode or Handsfree Talk mode. The handset switches to the headset.

- In the headset condition, the user can change Handsfree mode to Talk mode. However the handset keeps the headset condition.
- Insert the headset plug into the headset jack when in handsfree condition. The Handsfree icon remains on.
- A tone is emitted from the handset speaker when the headset is connected.

2.15 Volume Setting

The following modes have volume settings: Talk mode, Handsfree Talk mode and headset.

During each mode, you can press the **Up** (▲) or **Down** (▼) keys to increase or decrease the volume. As you increase/decrease the volume setting, the setting is displayed on the LCD from Level 1 to Level 6. After the volume is changed, the LCD shows the current volume setting for five seconds.

2.16 Ring Volume Setting

2.16.1 Ringer Tone/Volume Selection

When the **Volume** (soft key 1) key is pressed while in Standby, the handset switches to Ringer Volume Setting mode and the current setting is displayed on the LCD.

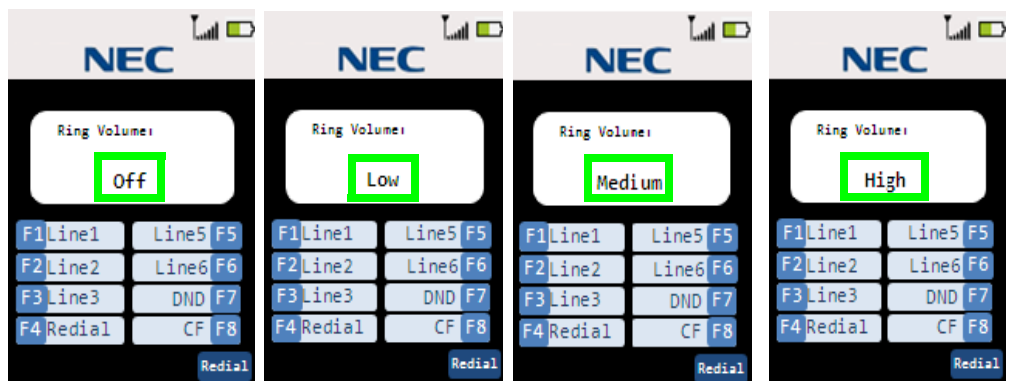

→ Up

← Down



- *The handset remains in Ringer Volume Setting mode for two seconds unless keys are pressed.*
- *You can use the handset to change the ringer volume while in Incoming Call mode. The ringer volume does not appear on the display.*
- *If Ringer Volume is off and the handset is on the charger while in Incoming Call mode, it rings Low, but does not vibrate.*
- *If ringer mute is on, the handset does not ring nor does it vibrate.*
- *Press the TALK key or Speaker key in Ring Volume Setting mode. The handset cancels the ringer volume setting and goes into Standby mode.*

2.17 Ringer Mute

If the **Volume Down** key is pressed and held for two seconds while in Standby mode or Incoming Call mode, the handset sets the ringer mute on, turns on the Ringer Mute icon and stops the ringer.

To turn the Ringer Mute off, press and hold the **Volume Down** key for two seconds; ringer mute is turned off.

SECTION 1 HANDSET FEATURES

 **IMPORTANT** — *The screens in this section are system-dependent and may not match your handset.*

The handset menu provides access to various features, which you can customize. These features include:

- Contacts List - allows you to add and modify your contacts list.
- Settings - allows you to adjust several handset settings such as menu timeout, LCD brightness, power save, audio equalizer and key lock.
- Sounds - allows you to select a ring tone, turn vibrate and out of range setting on/off and enable/disable key tone.
- Language - allows you to select one of three language settings (English, French or Spanish).
- Administrator Setting - allows you to register/de-register, change the pin code and scan the site for information about the handset.
- Function Key Labels - allows you to assign a label to the function keys.
- Key Lock - locks the keys after elapsed time period.
- Virtual Function Key - allows you to assign function keys that display on the handset's LCD.
- Base Key Option - allows you to display a Desk and H/S key on the handset's LCD.

SECTION 2 MAIN MENU

 **IMPORTANT** — *The screens in this section are system-dependent and may not match your handset.*

The handset main menu provides access to the various features. The features that are available from the Main menu, allow you to modify various settings as well as access to administrative features.

When you access the Main menu and select one of the menu items, the handset switches to Menu Setting mode.

The handset stays in Menu Setting mode for one minute, unless a key is pressed. When Handset Cancel menu setting is activated or you press the **Exit** or the **End Call** key while in Menu Setting mode; the handset switches to Standby mode.

2.1 Accessing the Main Menu

To access the Main menu:

1. Press the **Menu** key while in Standby mode. The menu list is displayed on the handset LCD.

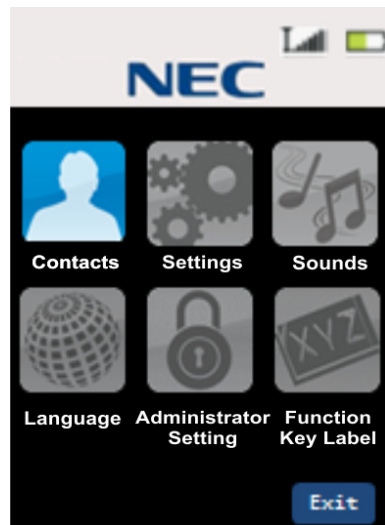

2. Select the menu items by scrolling up (▲), down (▼), left (◀) or right (▶). Press the **Select** key to open the menu item.
3. Press **Exit** to go back to the previous screen or Standby mode.

SECTION 3 MAIN MENU SELECTIONS

3.1 Contacts



The screens in this section are system-dependent and may not match your handset.

The Contacts menu item allows you to add, edit, delete or dial your contact members.

Use the up/down keys to select the Contacts menu item. Once the Contact menu is displayed, you can make the appropriate changes using the **Select** key.

3.1.1 List All Contacts

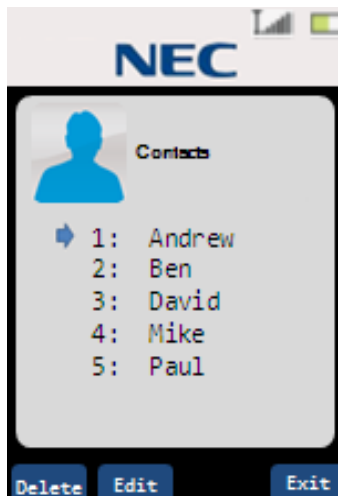

Keys available for listing contacts include:

To select contacts:

up (▲) / down (▼) - accesses the next contact in the list (forward/backward).

left (◀) / right (▶) - accesses the next five contacts in the list (forward/backward).

Select key - When the contact is selected, the details associated with the contact are listed

To edit contacts:

Delete key (Softkey 1) - deletes the contents of the selected contact.

Edit / Add key (Softkey 2) - edits the contents of the selected contact. If the selected contact is empty, the softkey indicates **Add**.

To dial from the contact list:

Talk/Speaker key - dials the selected contact.

3.1.2 Show Individual Contacts

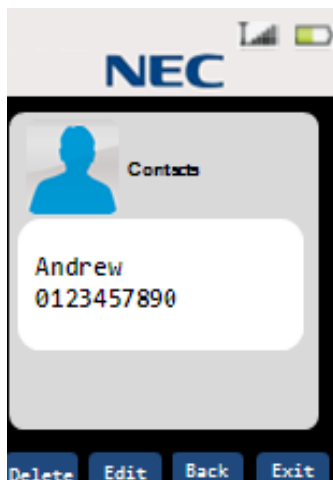

Keys available for showing individual contact members include:

To select contacts:

up (▲) / down (▼) - accesses the next contact in the list (forward/backward).

Back key - returns to the List screen.

To edit contacts:

Delete key (Softkey 1) - deletes the contents of the selected contact.

Edit / Add key (Softkey 2) - edits the contents of the selected contact. If the selected contact is empty, the softkey indicates **Add**.

To dial from the contact list:

Talk/Speaker key - dials the selected contact.

3.1.3 Delete Contacts

Select the contact using the **Select** key. Once the contact is selected, you can delete it.



Keys available for deleting a a contact include:

To delete contacts:

Yes key - deletes the contact from the list, emits a confirmation tone and returns the display to the previous screen.

No key - Does not delete the contact and returns the display to the previous screen.

3.1.4 Edit/Add Contacts

To add a contact:

1. Enter the contact name.
2. Enter the contact number.
3. Save the contact.

Contact Name

If adding a new contact, enter the name you wish to assign to the contact. If you are editing an existing contact, enter the name to access the contact.

➤ *A contact name is a maximum of eight characters.*



Add: Edit New

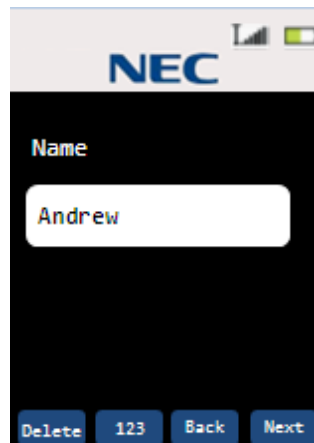

Edit: Rename

Keys available for editing/adding contact members include:

Back key - returns to the previous screen.

Next key - accesses the Number Edit screen.

123/abc key - toggles between numeric and alphabetic 'keypad'.

123 - allows numeric input.

abc - allows alphabetic input.

Delete key - deletes a character.

Right/Left key - moves the cursor to the right or left one character.

Alphabetic Input:

Dial keys:

Dial 1 : @._-^?!(),\W;~+=+1

Dial 2 : abcABC2

Dial 3 : defDEF3

Dial 4 : ghiGHI4

Dial 5 : jklJKL5

Dial 6 : mnoMNO6

Dial 7 : pqrsPQRS7

Dial 8 : tuvTUV8

Dial 9 : wxyzWXYZ9

Dial 0 : 0

Dial * : *

Dial # : #

Contact Numbers

If adding a new contact, enter the number you wish to assign to the contact. If you are editing an existing contact, change the number used to dial the contact.

- *A contact number is a maximum of 24 digits. If the number is over 16 digits, the number displays on two lines; 16 digits on the first line of the line of the display and the remaining digits on the second line.*

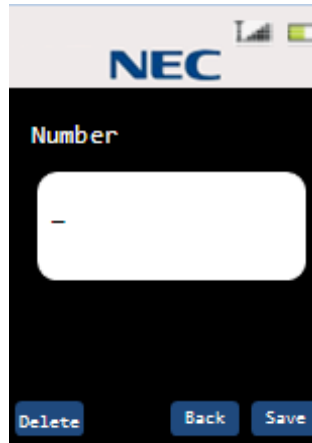

Add: Edit New

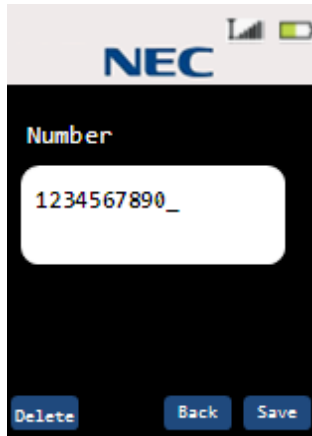

Edit: Rename

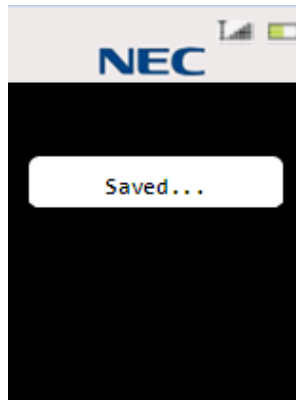

Contact Saved

Keys available for editing/adding contact members include:

Back key - returns to the previous screen.

Next key - accesses the Number Edit screen.

Delete key - deletes a character.

Save key - saves and stores the contact. A confirmation tone is emitted.

After two seconds, the display returns to either the Contact List or Individual Contact List view.

3.2 Settings

The settings menu items allows you to access and modify the DTZ-8R-1 settings.

Use the up/down keys to select the setting options. Once the settings menu is displayed, select the settings using the **Select** key.

3.2.1 List Settings

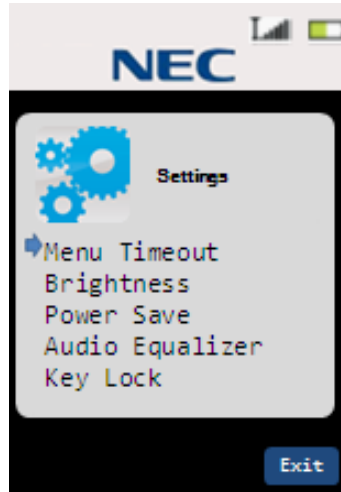

Keys available for listing settings options include:

To select settings:

up (▲) / down (▼) - accesses the next setting in the list (forward/backward).

Select key - displays the selected settings menu option screen.

3.2.2 Menu Timeout Settings

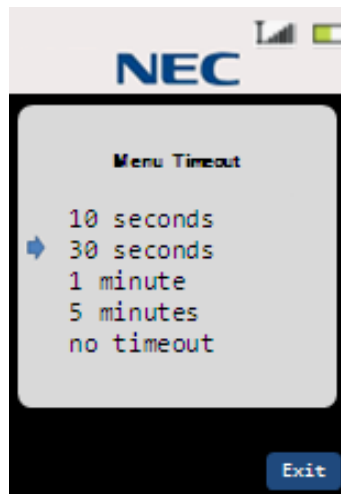

Keys available for timeout values include:

➡ *Default = 30 seconds.*

To select settings:

up (▲) / down (▼) - accesses the next setting in the list (forward/backward).

Select key - stores the selected timeout value, emits a confirmation tone and returns to the previous settings screen.

3.2.3 Brightness Settings



Keys available for brightness settings include:

➤ *Default = MAX.*

MAX = 100%

HIGH = 80%

MID = 60%

LOW = 20%

To select settings:

up (▲) / down (▼) - accesses the next setting in the list (forward/backward).

Select key - stores the selected timeout value, emits a confirmation tone and returns to the previous settings screen.

3.2.4 Power Save Settings

While in Standby or Talk mode, one minute elapses (without pressing any keys) and the phone enters Power Save mode.

To exit Power Save mode:

1. Press any key.

- OR -

Remove the handset from the charger unit.



Keys available for power save settings include:

➤ *Default = On.*

On = LCD is in sleep mode, the LCD back light is off

Off = LCD back light is dimly lighted

To select settings:

up (▲) / down (▼) - accesses the next setting in the list (forward/backward).

Select key - selects the desired setting and stores the selection. A confirmation tone is emitted. The previous screen (setting list) is displayed.

3.2.5 Key Lock Settings

This menu item allows you to enable/disable the handset Key Lock function.

To enable/disable the Key Lock function:

1. Use up/down arrow to access **On** (to enable) or **Off** (to disable).
2. Press **Select**.

Enable/Disable Key Lock:

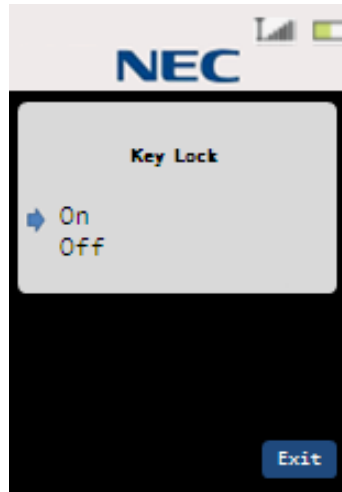

Keys available for key lock settings include:

➤ *Default = Off.*

On = Enable Key Lock function

Off = Disable Key Lock function

To select settings:

up (▲) / down (▼) - accesses the next setting in the list (forward/backward).

Select key - selects the desired setting and stores the selection. A confirmation tone is emitted. The previous screen (setting list) is displayed.

If the Key Lock function is enabled while the handset is in Standby mode, the keys are locked after 15 seconds elapse. You can temporarily unlock the keys for handset operation.

To unlock the keys:

1. Press and hold * for two seconds.

Temporarily Unlock Keys:



Keys available when unlocking the keys include:

* key - unlocks the keys until the handset is inactive for more than 15 seconds.

When you receive an incoming call, the Key Lock function is disabled for the duration of the call.

3.3 Sounds

The sounds menu items allows you to access and modify the DTZ-8R-1 ring tones, out of range alerts, key tones and turn vibrate on and off.

Use the up/down keys to select the menu items. Once the settings menu is displayed, you can make the appropriate changes using the **Select** key.

3.3.1 Sounds List Settings



Keys available for listing sounds settings include:

To select settings:

up (▲) / down (▼) - accesses the next setting in the list (forward/backward).

Select key - selects the desired setting and displays the options for the selected setting.

3.3.2 Sounds Ring Tone Settings

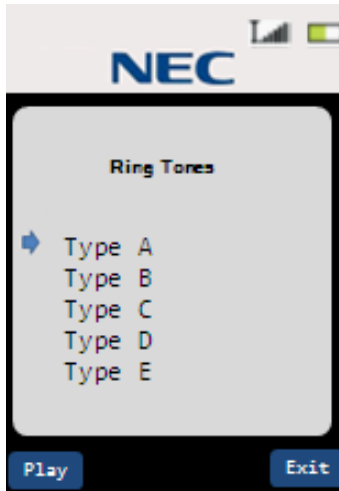

Keys available for ring tone settings include:

➡ *Default = Type A.*

To select settings:

up (▲) / down (▼) - accesses the next setting in the list (forward/backward).

Play key - plays a sample of the ringer tone for two seconds.

Select key - selects the desired setting and stores the selection. A confirmation tone is emitted. The previous screen (setting list) is displayed.

3.3.3 Sounds Vibrate Settings



Keys available for listing vibrate settings include:

➤ *Default = On.*

On = Vibrates when incoming calls are received

Off = The phone does not vibrate.

To select settings:

up (▲) / down (▼) - accesses the next setting in the list (forward/backward).

Select key - selects the desired setting and stores the selection. A confirmation tone is emitted. The previous screen (setting list) is displayed.

3.3.4 Sounds Out of Range Alert Settings



Keys available for out of range settings include:

➤ *Default = On.*

On = Out of Range alert is activated

Off = Out of Range alert is not activated

To select settings:

up (▲) / down (▼) - accesses the next setting in the list (forward/backward).

Select key - selects the desired setting and stores the selection. A confirmation tone is emitted. The previous screen (setting list) is displayed.

3.3.5 Sounds Key Tone Settings



Keys available for sounds settings include:

➤ *Default = On.*

On = Key Tone function is enabled

Off = Key Tone function is disabled

To select settings:

up (▲) / down (▼) - accesses the next setting in the list (forward/backward).

Select key - selects the desired setting and stores the selection. A confirmation tone is emitted. The previous screen (setting list) is displayed.

3.4 Language

The language menu items allows you to access and modify the DTZ-8R-1 language settings. There are three languages available; English, French and Spanish.

Use the up/down keys to select the menu items. Once the settings menu is displayed, you can make the appropriate changes using the **Select** key.

3.4.1 Language Settings

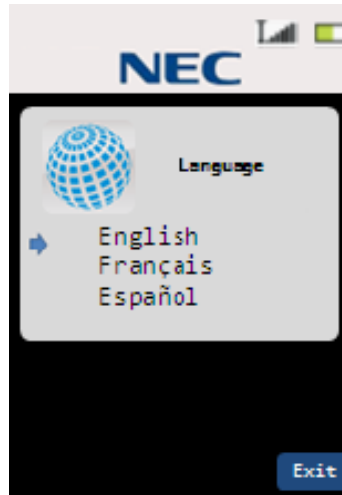

Keys available for listing language settings include:

➤ *Default = English.*

Available language:

- English
- French
- Spanish

To select settings:

up (▲) / down (▼) - accesses the next setting in the list (forward/backward).

Select key - selects the desired language setting and stores the selection.

3.5 Administrator Settings

The settings menu items allows you to access and modify the DTZ-8R-1 administrator settings. These settings allow the administrator to register/de-register handsets, change pin codes and conduct a site survey to assess the condition of the handsets.

Use the up/down keys to select the menu items. Once the settings menu is displayed, you can make the appropriate changes using the **Select** key.

3.5.1 Administrator List Settings

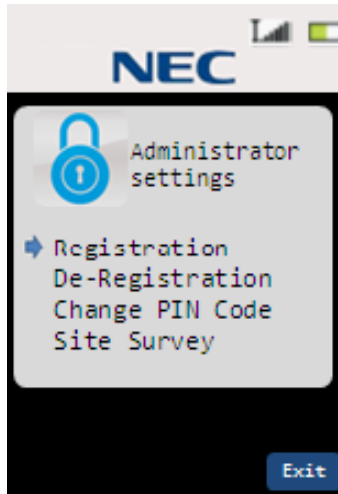

Keys available for listing the administrator settings include:
 up (▲) / down (▼) - accesses the next setting in the list (forward/backward).
Select key - selects the desired setting and displays the screen.

3.5.2 Administrator Registration Settings

This setting allows the administrator to register the handset.

To register the handset:

1. Press and hold the left key on base station until the blue LED blinks (three seconds).
2. Select **Registration** from the Administrator Settings menu list.
3. Press the **Select** key. The LCD displays the Registration screen.
4. Enter the **Registration Pin** number.
5. Press **OK** to send the pin number to the base station.

Handset searches for the base station:

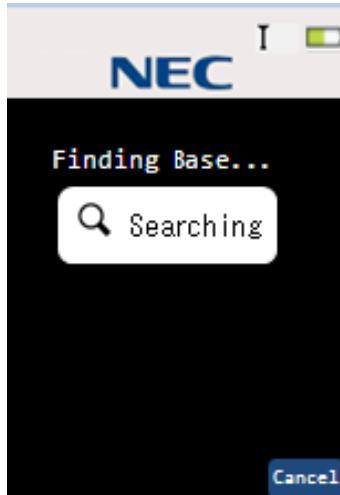

Keys available when registering the handset include:

Cancel key - exits registration mode.

Enter Registration Pin:

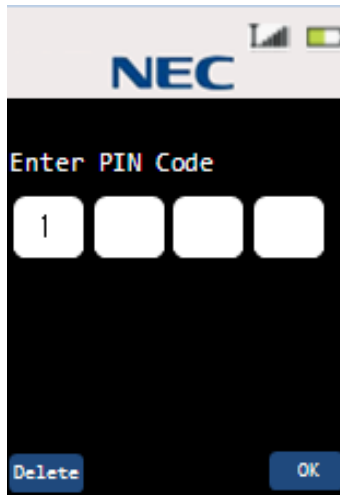

Keys available when registering the handset include:

➔ *Default = 1234.*

Delete key - deletes one digit.

Dial (0~9) key - numeric keys to used to enter the pin code.

OK key - sends the registration pin to the base station.

Finish Registration:

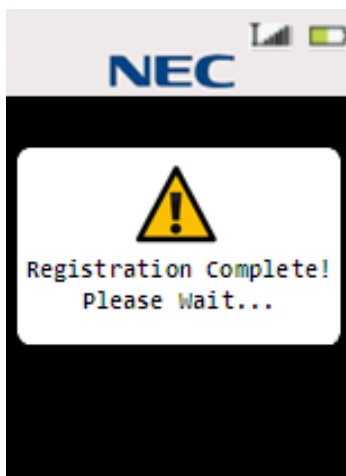

Keys available when registering the handset include:

- *After five seconds, the handset switches to one of the following modes; depending on the success or failure of handset registration.*

If registration is successful, the handset switches to Standby mode.

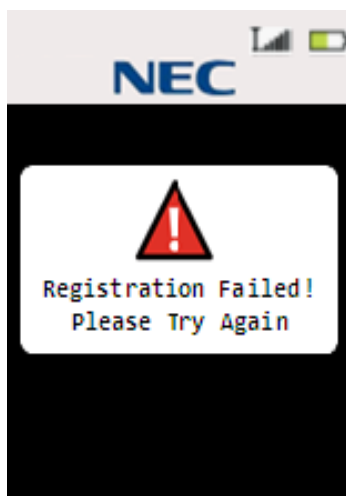

If the registration fails, the handset switches to De-register or Standby mode.

3.5.3 Administrator De-registration Settings

This setting allows the administrator to de-register the handset.

To de-register the handset:

1. Use the up/down key to select the handset you want to de-register.
2. Select **Yes** to de-register the handset.

Select handset:

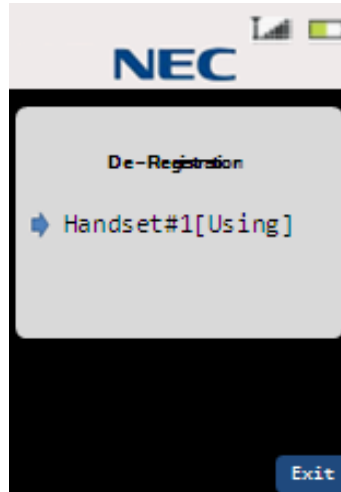

The handset number is displayed.

Keys available when de-registering the handset include:

up (▲) / down (▼) - accesses the next setting in the list (forward/backward).

Select key - selects the desired setting and stores the selection. Displays the Confirmation screen.

De-register the handset:



Keys available when de-registering the handset include:

Yes key - starts de-registration.

No key - returns the handset to Standby mode.

Finish Registration:

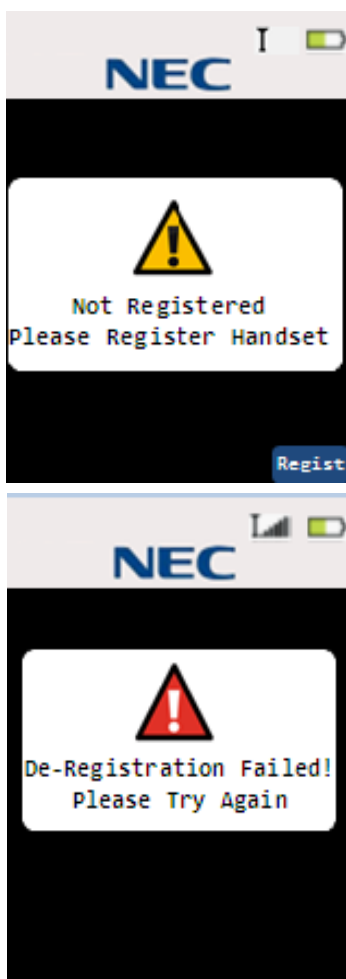

Keys available when de-registering the handset include:

- *If de-registration is successful, the LCD displays the message indicating the handset is not registered. You can register the handset again using the **Regist** key.*

Regist key - starts registration.

If de-registration failed, the handset switches to Standby mode after five seconds have elapsed.

3.5.4 Administrator Change Pin Code Settings

This setting allows the administrator to change the pin code.

To change the pin code:

1. Select **Change Pin Code** from the Administrator Setting List.
2. Press the **Select** key.
3. Change the pin code on the Change Pin Code screen.
4. Press **OK** to register the new pin code.

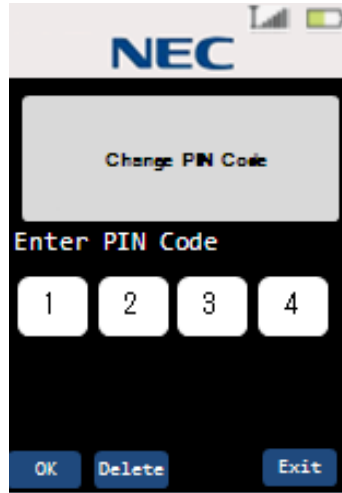

When this setting is selected, the handset starts communicating with the base station to obtain the pin code. The base station sends the pin code to the handset and it is displayed on the handset's LCD.

Keys available when changing the pin code include:

Delete key - deletes one digit.

Dial (0~9) key - numeric keys used to enter the pin code.

OK key - sends the registration pin to the base station. A confirmation tone is emitted.

3.5.5 Administrator Site Survey Settings

This setting allows the administrator to initiate a site survey to collect information about the handsets.

To change the pin code:

1. Select **Site Survey** from the Administrator Setting List.
2. Press the **Select** key.
3. On the Site Survey screen, press the **Scan** key. The results of the scan are displayed on the handset's LCD.

Scan for information:

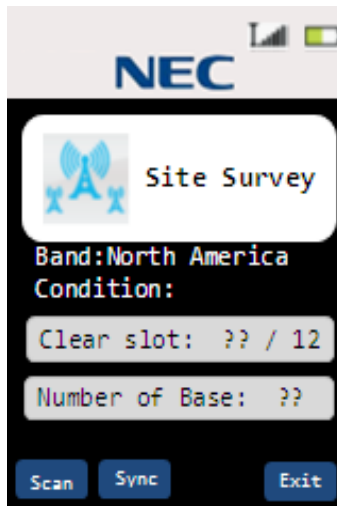

This screen displays the following information:

- Band** - the carrier band for the handset.
- Condition** - Good / Fair / Poor
- Clear Slot** - number of clear slots (total number of slots is 12).
- Number of Base** - the number of the base station.

Keys available when requesting a site survey include:

- Scan** key - begins scanning for clear slots and the number of the associated base station.
- Sync** key - begins Sync display mode.

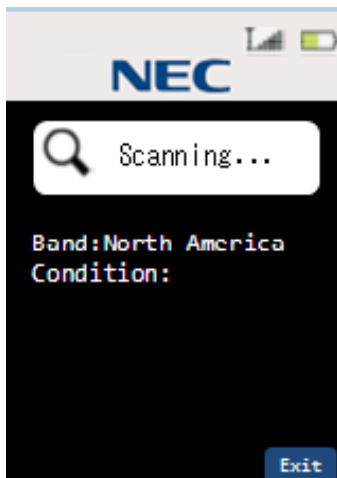

Scanning begins collecting information (this takes about 30 seconds).

Scan complete; information displayed:

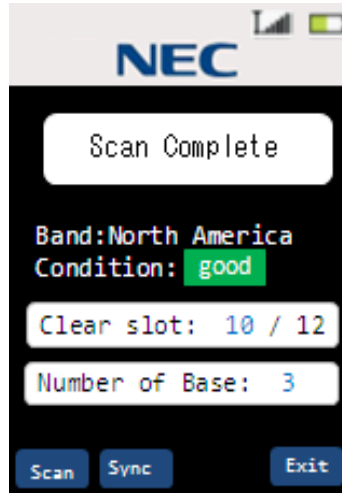

The results of the scan are displayed in the LCD.

Band - the carrier band for the handset.

Condition - Good / Fair / Poor

Clear Slot - number of clear slots (total number of slots is 12).

Number of Base - the number of the base station.

Keys available when requesting a site survey include:

Scan key - restarts scanning for clear slots and number of base stations.

Sync key - begins Sync Display mode.

3.5.6 Administrator Site Survey Settings - Sync Display Mode

To start Sync Display mode:

Press the **Sync** key.

Start Sync Display mode:

```
Ch 3 / Slot 2: RSSI:38
BER : 00 RFPI:01223524A0
H/O:On Lost: 01 [L]
```

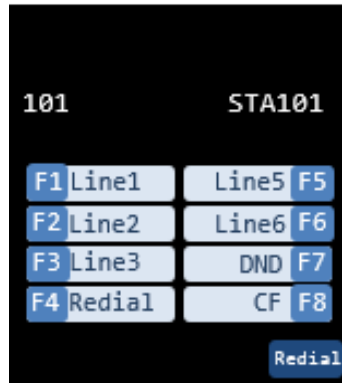

When the **Sync** key is pressed, the Sync Display mode displays the following information:

Ch - the current channel number.

Slot - the current slot number.

RSSI - the current RSSI (Receive Signal Strength Indication) value.

BER - the Bit Error Rate.

RFPI - the RFPI (Radio Fixed Part Identity) or base station ID.

H/O - Hand Over Enable/Disable

Lost - Lost counter

L - status (locked or unlocked)

3.6 Function Key Labels

The Key Label menu item allows you to assign, edit or delete labels for the eight function keys.

To access the Key Labels menu:

Select **Key Labels** from the main menu using the **Select** key.

3.6.1 Key Label List Settings

This screen allows you to access the function key labels. Once you have selected the function key, you can assign, edit or delete the label.

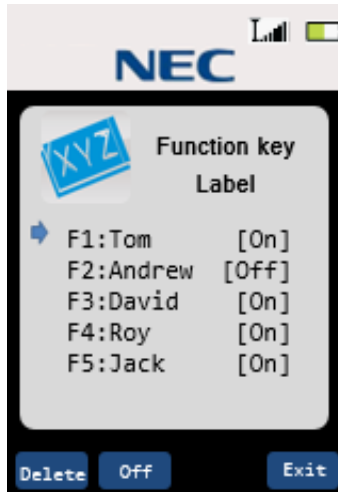

There are eight function keys that can be assigned labels.

Keys available when accessing the key labels include:

up (▲) / down (▼) - accesses the next setting in the list (forward/backward).

Select key - selects the desired label.

Delete key - deletes the label name.

On/Off key - toggles between enabling/disabling the function key.

3.6.2 Key Label Name Edit Settings

This menu item allows you to edit the name of the function key label.

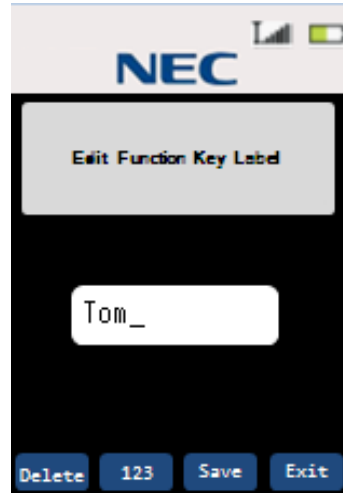

A maximum of eight characters can be stored for each label.

Keys available when changing the label name include:

123/abc key - toggles between numeric and alphabetic 'keypad'.

123 - allows numeric input.

abc - allows alphabetic input.

Alphabetic Input:

Dial keys:

Dial 1 : @._-&'^?!(),\W:;~+=+1

Dial 2 : abcABC2

Dial 3 : defDEF3

Dial 4 : ghiGHI4

Dial 5 : jklJKL5

Dial 6 : mnoMNO6

Dial 7 : pqrsPQRS7

Dial 8 : tuvTUV8

Dial 9 : wxyzWXYZ9

Dial 0 : 0

Dial * : *

Dial # : #

Right/Left key - moves the cursor to the right or left one character (only available for alphabetic input).

Delete key - deletes the character where the cursor is positioned.

Save key - stores the function key label name.

3.6.3 Key Label Delete Label Settings

This menu item is used to delete a function key label name. This screen is displayed when the **Delete** key is pressed on the Edit Function Key Label screen.

To delete the label name:

Press **Yes**.



Keys available when changing the pin code include:

Yes key - deletes the function key label.

Not key - returns to the previous screen.

SECTION 4 ADDITIONAL HANDSET FEATURES

 **IMPORTANT** — *The screens in this section are system-dependent and may not match your handset.*

4.1 Virtual Function Keys

You can access virtual function keys by entering Virtual Function Key mode. You can enter Virtual Function Key mode while the handset is in Standby mode, when receiving an incoming call or while talking.

To enter Virtual Function Key mode:

Press the **Select / Talk** or **Speaker** key.

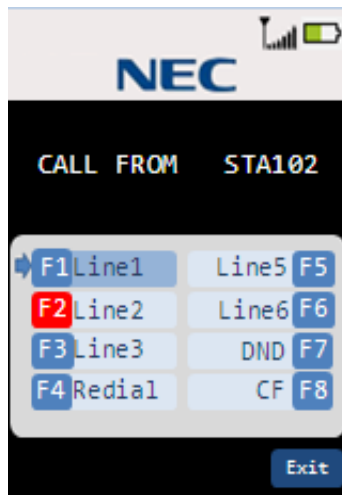

Keys available when switching to Virtual Function Key mode include:

up (▲) / down (▼) - accesses the next setting in the list (forward/backward).

Select key / **Talk** key / **Speaker** key - sends the function key code to the base station.

INDEX

Numerics

- 16-hour talk time 1-3
- 4-day standby time 1-3

A

- AC adapter 1-2, 2-2, 3-3, 5-1
- adapter 5-1
- administrator
 - change pin code 7-20
 - de-registration 7-18
 - list 7-15
 - registration 7-15
 - site survey 7-21
 - sync display mode 7-22
- answer
 - any key 1-3
- applying power to 3-3
- AutoStandby 2-3, 6-15

B

- back light
 - keys 1-3
 - LCD 1-3
- base unit 1-2, 2-2
 - adapter 5-1
 - controls 4-3
 - power requirements 1-2
 - receive frequency 1-2
 - size 1-2
 - transmit frequency 1-2
 - weight 1-2
- batteries
 - nickel-metal hydride 1-4
 - NiMH 1-4
- battery 1-3
 - AAA Ni-MH 1-3
 - batteries 5-1
 - charging 3-3, 3-8
 - charging unit 1-3, 2-3
 - cleaning 3-10
 - handset 3-7
 - low indication 3-9, 3-10
 - nickel-metal hydride 1-4
 - rechargeable 2-2, 5-1
 - recycling 1-4
 - safety considerations 1-4
- belt clip 2-2, 5-1

C

- Canadian Standards Association 1-1

- certification label 1-1
- change channel 1-3
- channel
 - automatic selection 2-3
- channel change 1-3
- charger unit 2-7
 - buttons 2-5
- charging
 - handset battery pack 3-8
 - stand 2-2
 - unit 1-3, 2-3, 3-3
- charging unit 5-1
- cleaning battery contacts 3-10
- conference key 4-2
- contacts 7-3
 - delete 7-5
 - edit/add 7-5
 - list all 7-3
 - numbers 7-7
 - show individual 7-4
- conversation mode 4-2
- cordless LED 4-3
- CSA 1-1

D

- data transmission speed 1-2
- direct wall mounting installation 3-4
- display
 - LCD 1-3

F

- FCC 1-2, 1-7
- FCC Part 15 rules 1-1
- FCC Part 68 1-2
- features
 - automatic channel selection 2-3
 - charging unit 2-3
 - handset
 - design 2-3
 - volume 2-3
 - headset
 - jack 2-3
 - volume 2-3
 - mute control 2-3
 - single key access 2-3
 - virtual function keys 7-26
- frequency
 - control 1-2
 - receive 1-2
 - transmit 1-2

H

- handset 1-3, 2-2
 - battery 1-3
 - battery pack 3-7, 3-8
 - controls 4-1
 - design 2-3
 - features 7-1
 - administrator setting 7-1
 - base key option 7-1
 - contacts list 7-1
 - function label keys 7-1
 - key lock 7-1
 - language 7-1
 - settings 7-1
 - sounds 7-1
 - virtual functions key 7-1
 - kit 5-1
 - operation 6-5
 - AutoStandby 6-15
 - battery status 6-18
 - call extension 6-6
 - handsfree 6-18
 - headset 6-19
 - low battery 6-18
 - making outside call 6-11
 - mute 6-18
 - no service 6-16
 - out of range 6-16
 - receive external call 6-13
 - redial 6-15
 - retrieve call from extension 6-10
 - ring volume 6-19
 - ringer mute 6-20
 - switch to cordless 6-5
 - switch to wired phone 6-5
 - volume setting 6-19
 - power requirements 1-3
 - receive frequency 1-3
 - size 1-3
 - talk mode 1-3
 - transmit frequency 1-3
 - volume 2-3
 - volume control 1-3
 - weight 1-3
- handset features
 - virtual function keys 7-26
- handsfree 1-3
 - talk mode 4-2
 - volume control 1-3
- headset 5-1
 - installing 5-2
 - jack 1-3, 4-3
 - volume 2-3
 - volume control 1-3
- hearing aid compatible 1-2, 1-3

I

- indications

- battery low 3-9, 3-10
- installation precautions 3-1
- installing
 - direct wall mounting 3-4
 - handset battery pack 3-7
 - headset 5-2
 - selecting location 3-1

K

- keys
 - any key answer 1-3
 - back light 1-3
 - base key option 7-1
 - conference 4-2
 - hold key 4-2
 - lock 7-1
 - talk key 4-2
 - virtual 7-1
 - virtual function 7-26
- kit
 - handset 5-1

L

- language 7-14
 - settings 7-14
- LCD
 - back light 1-3
 - display 1-3
- LED
 - cordless 4-3
 - NEC multiline terminal 4-3
 - power 4-3
- line problems 1-6, 1-7
- lock keys 7-1

M

- main menu 7-2
 - selections
 - administrator 7-14
 - contacts 7-3
 - language 7-14
 - settings 7-8
 - sounds 7-11
- menus
 - administrator 7-14
 - contacts 7-3
 - handset 7-2
 - language 7-14
 - main 7-2
 - settings 7-8
 - sounds 7-11
- modes
 - conversation 4-2
 - handsfree talk 4-2
 - on-hook 4-2

- programming 6-1
- standby 4-2, 7-2
- talk 4-2
- training
 - change item 6-2
 - entry 6-1
 - exit 6-2
 - select item 6-2
- modulation 1-2
- multiline telephone
 - using 6-1
- mute control 2-3

N

- NEC multiline terminal LED 4-3
- nickel-metal hydride batteries 1-4
- nickel-metal hydride battery 1-3, 1-4
- Ni-MH batteries 1-4, 5-1

O

- occupied bandwidth 1-2
- optional accessories
 - headset 5-1
- out of range
 - alarm tone 1-3
 - detection 1-3
- output power 1-2

P

- phase lock loop 1-2
- power LED 4-3
- power requirements 1-2
- privacy 1-6
- programming mode 6-1

R

- r/vol key 4-3
- radio frequency interference 1-1
- radio interference 1-7
- range 1-6
- receive frequency 1-3
- rechargeable batteries 5-1
- recycling 1-4
- regulatory
 - Canada CS-03 Part V 1-2
 - certification label 1-1
 - FCC Part 15 rules 1-1
 - FCC Part 68 rules 1-2
- ringer
 - mute 1-3
 - tone 1-3
 - vibrating 1-3

S

- safety
 - battery 1-4
 - general instructions 1-4
- safety information 1-1
- settings
 - brightness 7-9
 - key lock 7-10
 - list 7-8
 - menu timeout 7-8
 - power save 7-9
- single access key 2-3
- site location 3-1
- soft keys 1-3
- sounds
 - key tone 7-13
 - list 7-11
 - out of range alert 7-12
 - ring tone 7-11
 - vibrate 7-12
- specifications
 - base unit 1-2
 - frequency 1-2
 - frequency control 1-2
 - handset 1-3
 - modulation 1-2
 - phase lock loop 1-2
 - power requirements 1-2
 - spread spectrum 1-2
 - standby mode 1-3, 4-2, 7-2

T

- talk
 - key 4-2
 - mode 1-3, 4-2
- telephone
 - base unit 2-2
 - belt clip 2-2
 - charging stand 2-2
 - cord 2-2, 5-1
 - connecting 3-1
 - features 2-3
 - handset 2-2
 - headset 5-1
 - line problems 1-6, 1-7
 - multiline telephone 6-1
 - privacy 1-6
 - radio interference 1-7
 - range 1-6
 - rechargeable battery 2-2
 - wall plate adapter 2-2
- telephone cords 5-1
- temperature
 - specifications 1-2
- transmit frequency 1-3

V

virtual function keys 7-26

volume

control

high 4-3

low 4-3

maximum 4-3

medium 4-3

handset 1-3

handsfree 1-3

headset 1-3

setting 6-19

W

wall mounting

charging unit 2-3

direct 3-4

wall plate adapter 2-2

***D^{term}*® Cordless DECT
Owner's Manual
DTZ-8R-1**