



# Before using Your Terminal...

Thank you for purchasing NEC SL2100 system.

Due to the flexibility built into the system, your **Dialing Codes and Feature Capacities** may differ from those in this guide. Check with your NEC Authorized Supplier / System Administrator and make a note of any differences.

## Installing the Handset and LAN Cable

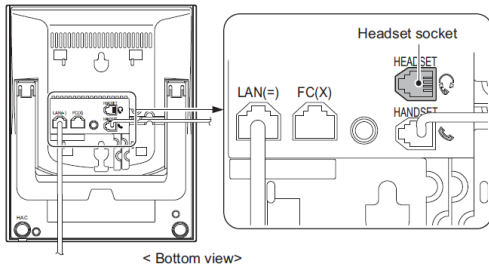

### When installing the handset :

1. Make sure the handset cord is plugged into the handset jack on the telephone base.
2. The LAN cable routes through the channel on the telephone base or the telephone legs. (The LAN cable is customer provided.)

\* Power Feeding: PoE (IEEE802.3af) Only

## Adjust the two-position Viewing Angle

### To set the low viewing angle position:

1. Fold the legs all the way back.

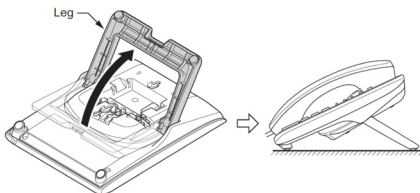

### To set the high viewing angle position:

1. Flip up the two leg supports.
2. Fold the legs back until the supports contact the base.

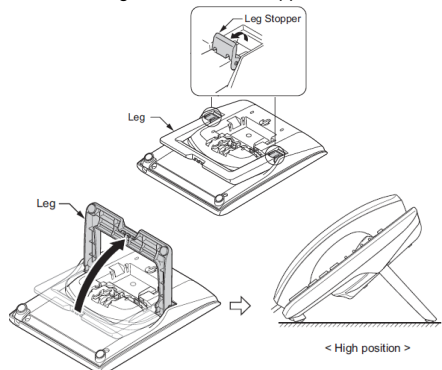

NEC Corporation reserves the right to change the specifications, functions, or features at any time without notice. NEC Corporation has prepared this document for use by its employees and customers. The information contained herein is the property of NEC Corporation and shall not be reproduced without prior written approval of NEC Corporation.

Copyright 2017, NEC Corporation

# Using Your Terminal

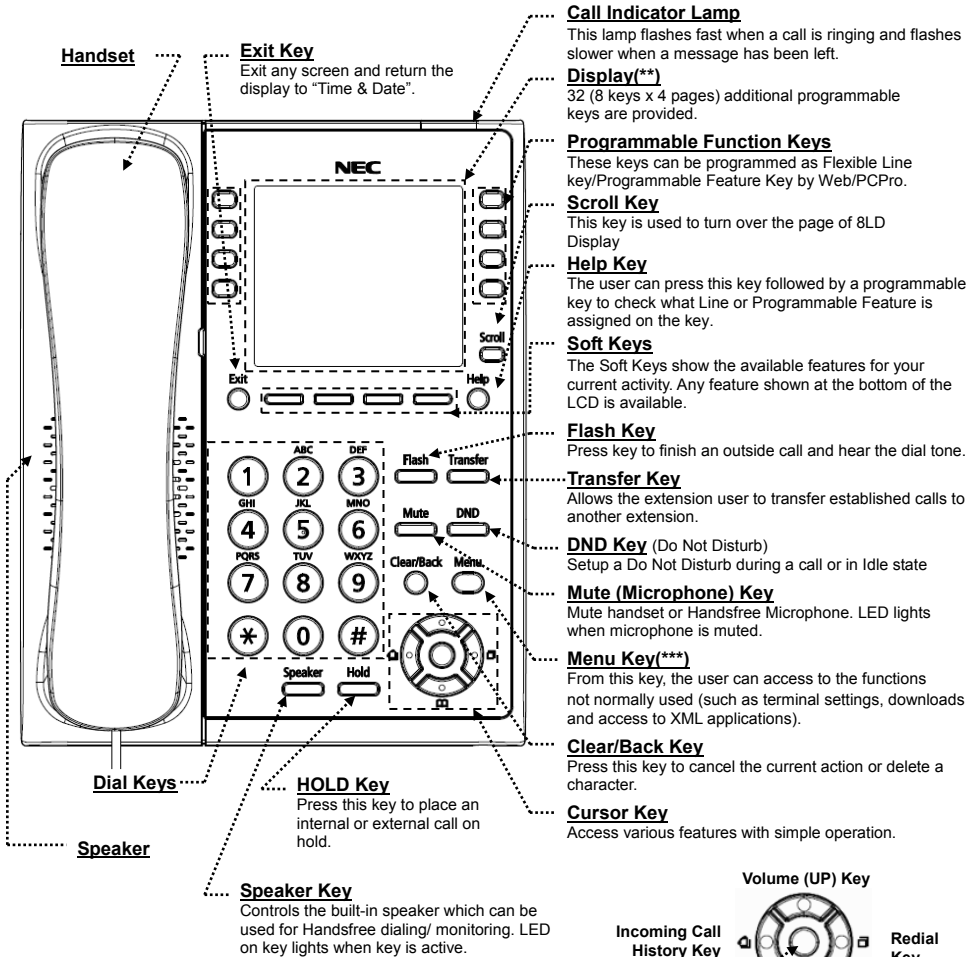

\* The illustration shows IP7WW-8IPLD-C1 TEL

\*\* Up to "8" physical keys are available and it can be expanded up to 32 keys by changing the "DESI-Less Page" by pressing the Scroll Key.

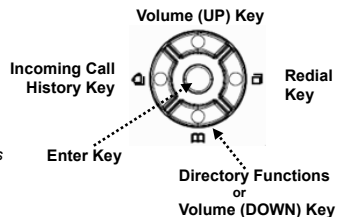

## Handsfree Options

- Handsfree lets you place and answer calls by pressing "Speaker" instead of using the handset.
- With Automatic Handsfree, you can press a Speaker Key without lifting the handset. Normally, you have Automatic Handsfree.
- Use Handsfree Answerback to answer a voice-announced Intercom call by speaking toward your phone without lifting the handset.

# Using Your Terminal

## \*\*IP7[ ]-8IPLD-C1 Display

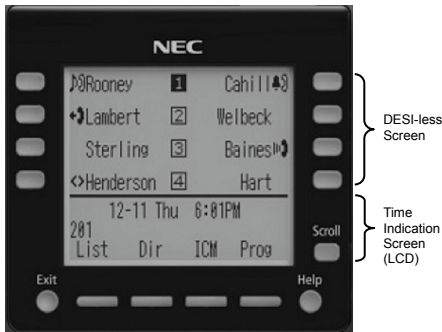

32 (8 keys x 4 pages) additional programmable keys are provided. They can be programmed as Flexible Line/Programmable feature key by Telephony Server Administrator. For the SL2100, the programmable keys can be set by WebPro/PCPro/Tel Pro and user can also set them.

**Note:** Maximum 11 characters (including icon)  
Maximum 13 Characters (including icon)

### 1) Icon

Status of the Line key such as Call Ringing, Call Hold or Busy, and setting on the Feature key are shown as Icons.

| User's Status   | Icon    | Flashing Pattern |
|---|---------|------------------|
| Idle  | No Icon | -                |
| I-HOLD  |         | Blink            |
| Others Hold   |         | Blink            |
| Recall  |         | Blink            |
| Incoming Ringing  |         | Blink            |
| -During Conversation (Individual Use)<br>-Call Transfer<br>-Conference  |         |                  |
| -During Conversation (Other Party Use)<br>-Active Feature (Under a setting of feature key like a "Call Forwarding") |         |                  |
| Others  |         | Steady Lit       |
| -Key is busy (example, if programmed as a virtual extension and the virtual extension is busy).                     |         | Steady Lit       |

## 2) Feature Key Information

Feature Key Information displays the followings.

| Key                      | Description   | Maximum digits to be displayed |
|--------------------------|---|--------------------------------|
| Line Key                 | Name and Number Information                         | Refer to Note*                 |
| Feature Key              | Feature Name  | Refer to Note*                 |
| One-Touch Speed Dial Key | -Speed Dial Name Information<br>-Number Information | Refer to Note*                 |

**Note\*:** Maximum 11 characters (including icon)  
Maximum 13 characters (excluding icon)

## 3) LCD

LCD (Liquid Crystal Display) provides SL2100 activity information plus date, time and Softkey Operation.

The LCD on the IP7[ ]-8IPLD-C1 has a 28-character and 3-line capability.

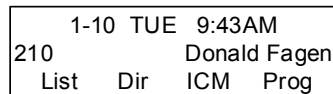

## \*\*\*Menu Key

From the Menu Key, the user can use various application features.

### 1) To Display Menu List

Press the Menu Key. The Menu List is displayed in LCD. Use Cursor Key to select desired Menu Items.

| No. | Menu Item | Description   |
|-----|-----------|---|
| 1   | Setting   | To set up the terminal such as ringing tones setting and download of Music on Hold...etc. |
| 0   | Config    | This item is used for Configuration setting of IP7WW-8IPLD-C1 terminal.                   |

### 2) Simple Operation by Menu Key and Cursor Key

By using Menu Key and Cursor Key, Terminal user can have access to terminal settings with simple operation. As an example, the following shows the operations how to access to Directory menu.



Ask your NEC Authorized Supplier for the details.

# For Your Convenience

## ■ Programmable Function Keys

Programmable Function Keys can be assigned as “Trunk” Key and/or other Function Keys. You can just press the function key to activate the assigned function without dialing the Service Code.

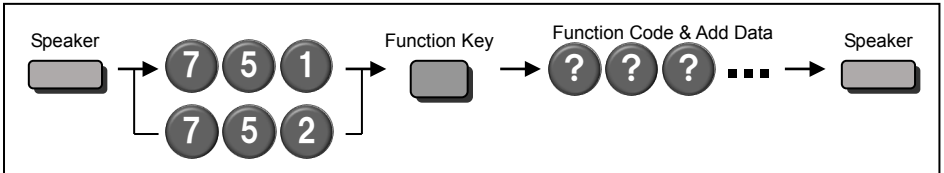

- There are 2 levels of Function Keys. (General Keys : assigned by 751, Appearance Keys : assigned by 752)
- Appearance Keys have priority. You can overwrite the Appearance Key at the General Key.
- If you want to overwrite the General Key at the Appearance Key, **you have to erase the Appearance Key by dialing “752 + 000” before General Key assignment.**
- In the default setting, Programmable Function Key No. 1 to 12 is assigned as “Trunk” Key. If you want to assign Function Keys (General) at the unused Trunk Keys, these unused keys should be erased by “752 + 000” operation.
- Programmable Function Keys can be erased by dialing “752 + 000” or “751 + 00”.
- Programmable Function Keys can be assigned by Soft Key operation as well.

## ■ DSS / One-Touch Keys

Programmable Function Keys can be assigned as DSS (Direct Station Selection) or One-Touch Keys. You can place an Outside / Intercom Call by just pressing this key without dialing the number.

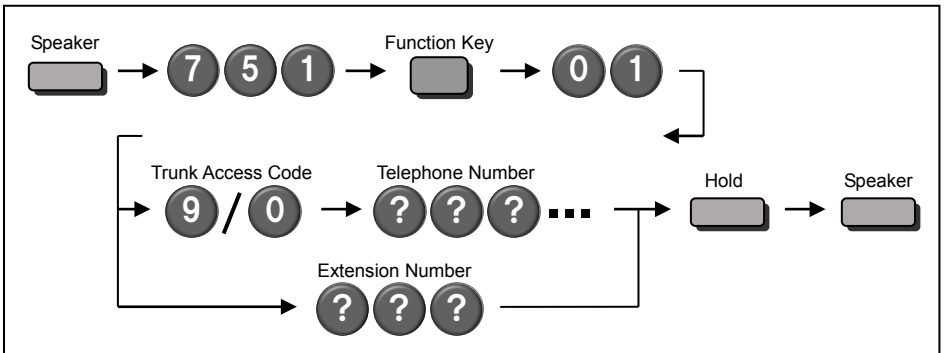

- To change the Trunk Access Code, Ask your NEC Authorized Supplier for the details.
- In the default setting, Programmable Function Key No. 1 to 12 is assigned as “Trunk” Key. If you want to assign DSS Keys at the unused Trunk Keys, these unused keys should be erased by “752 + 000” operation before the above operation.
- In case of DSS Key, the extension status can be indicated on the BLF. (idle : extinguished, Busy : lit)
- When you register a telephone number, the Trunk Access Code should be added in front of the number.
- Up to 36 digits dialing can be registered, but the name can not be registered.
- If you want to continue the operation, press Programmable Function Key instead of Speaker Key to finish.
- One-Touch Keys can be assigned by Soft Key operation as well.

# For Your Convenience

## ■ Abbreviated Dial (Speed Dial) Registration

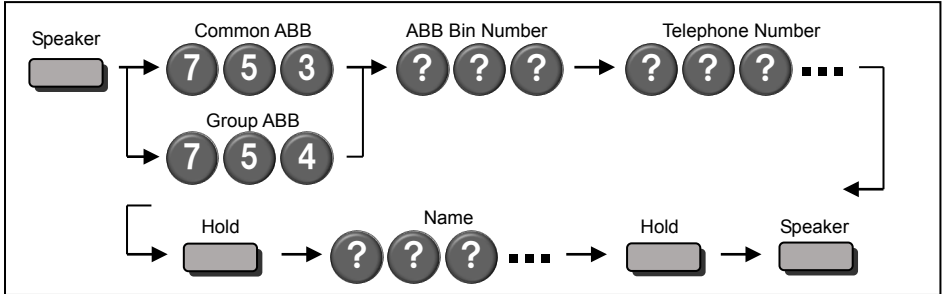

- The digit of Bin No. depends on the system setting. (0-9<Only Group ABB> / 00-99 / 000-999)
- System setting is necessary for Group ABB function. Ask your NEC Authorized Supplier for the details.
- Name can be entered by Dial Pad Keys. (See below)
- Up to 36 digits dialing can be registered, and up to 12 characters can be registered as name.
- If you want to continue the operation, dial Bin No. instead of Speaker Key to finish.
- You can skip to enter the name. (No enter any character, then press "Hold" Key).
- You can erase the registered number & name by pressing "Exit" Key after dialing Bin No.
- Common Abbreviated Dial can be registered by Soft Key / Cursor Key operations as well.

## ■ Entering Alphanumeric Characters

When you enter a name, use Dial Pad Keys to enter letters as below. For example, press "2" key once for "A", twice for "B", etc...

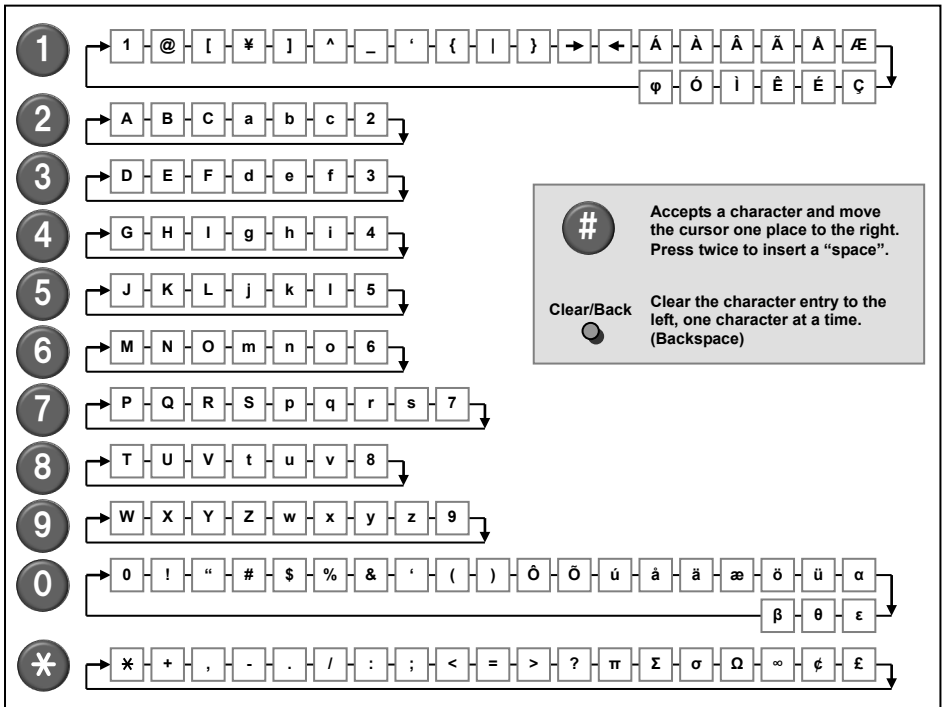

# Placing Calls

## ■ Place an Outside Call <Quick Access>

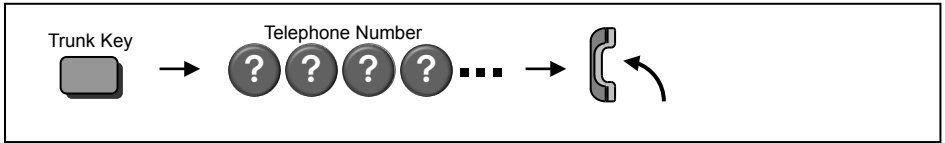

- Listen to the Dial Tone before dialing a Telephone Number.
- You can have function keys for Trunks or Trunk Groups. Ask your NEC Authorized Supplier for the details.

## ■ Place an Outside Call <Access by Code>

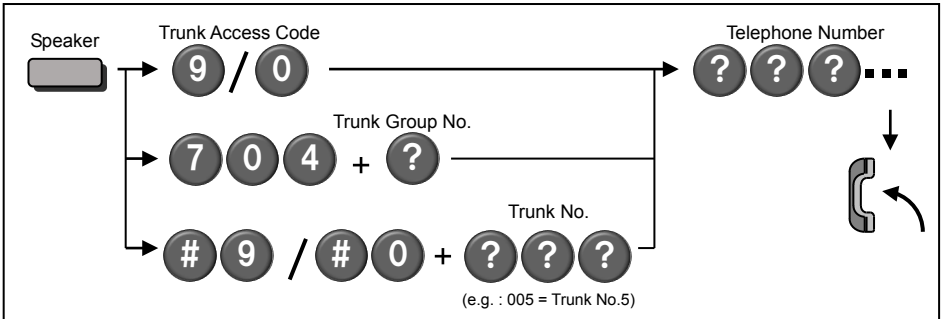

- To change the Trunk Access Code, Ask your NEC Authorized Supplier for the details.
- Listen to the Dial Tone before dialing a Telephone Number.
- In case the number of Trunk Group is more than 10, you should enter 2 digits (e.g. 11 : Group 11) after dialing "704". Ask your NEC Authorized Supplier for the details.
- For the dial digit of Trunk No., ask your NEC Authorized Supplier for the details.

## ■ Place an Intercom Call <Dial Access>

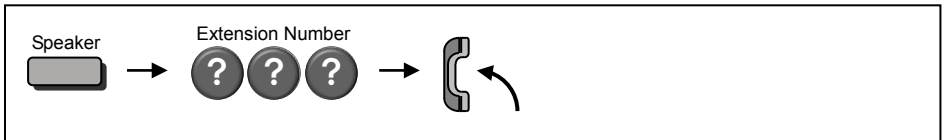

- Your call will ring or voice-announce. If you hear ringing, wait for an answer. If you hear a beep, begin speaking. Dialing "1" changes voice/ring mode. (in case the destination is Multi-line Terminal)

# Placing Calls Quickly

## ■ Directory Dialing

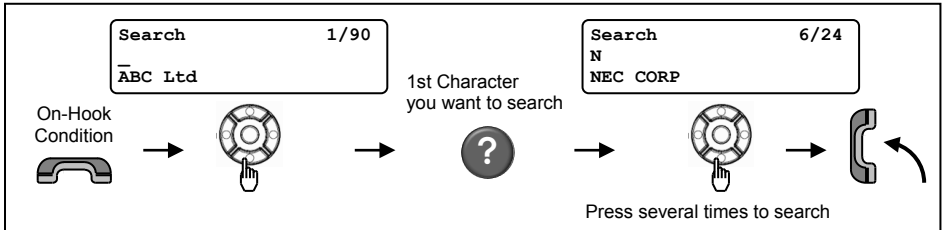

- After searching the desired destination, press “Enter” Key to confirm the telephone number before lifting the handset, if necessary.
- You can enter more Characters (up to 12) to make desired destination’s search even more specific.
- You can also search the desired destination without entering the Characters. (press Cursor Keys only)
- To cancel the Directory Dialing operation, press “Clear/Back” Key.
- Directory Dialing can be activated by Soft Key operation as well.

## ■ Last Number Dialing

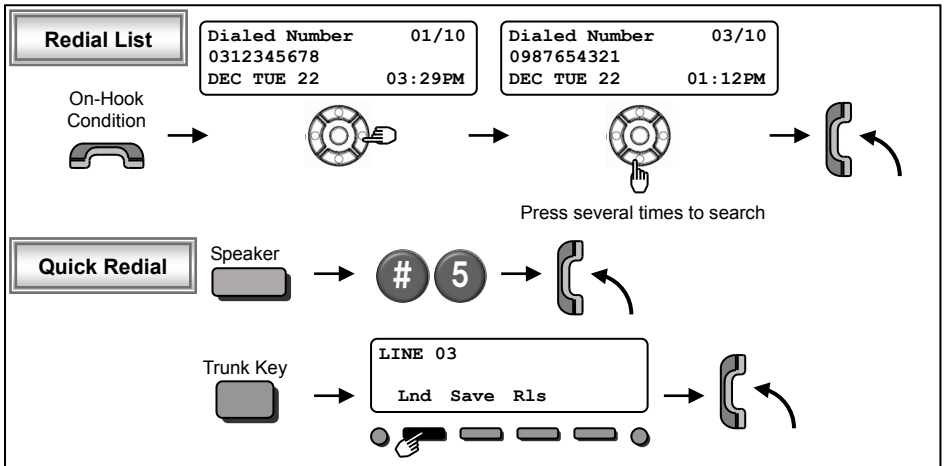

- The system retains the last 10 numbers dialed which can be reviewed and redialed.
- To cancel the Redial List operation, press “Clear/Back” Key.

## ■ Callback by Received Number

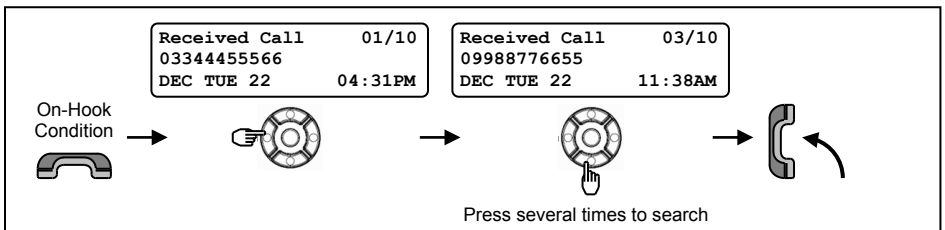

- Caller-ID function is required to use this operation for outside calls. Ask your NEC Authorized Supplier for more details.
- To cancel the Callback operation, press “Clear/Back” Key.



# Placing Calls Quickly

## ■ Abbreviated (Speed) Dialing <for Outside>

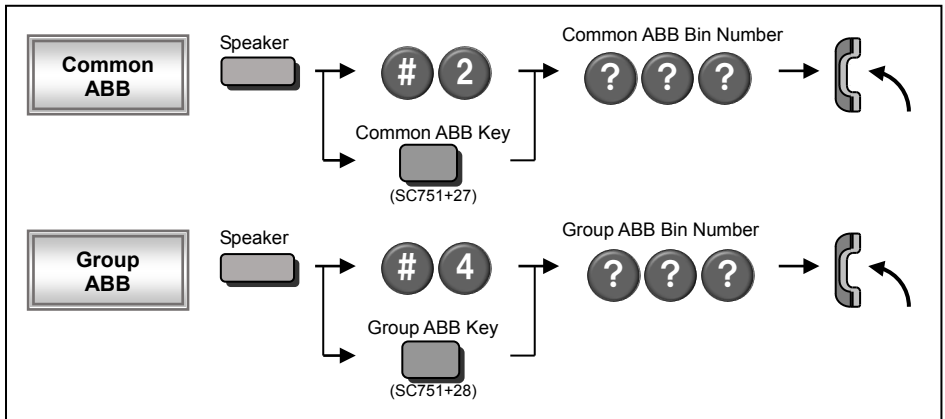

- The digit of Bin No. depends on the system setting. (0-9 <Only Group ABB> / 00-99 / 000-999)
- Telephone Numbers shall be pre-registered to the system.
- System setting is necessary for Group ABB function. Ask your NEC Authorized Supplier for the details.
- When you assign the Common ABB Key on the Programmable Function Key, "Press HOLD" is required after dialing the Function Code 27.

## ■ One-Touch / DSS Call

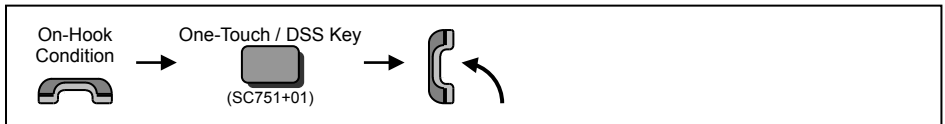

- Telephone / Extension number should be pre-registered to a One-Touch / DSS Key.
- Trunk Access Code should be added in front of the Telephone number.

# If your call doesn't go through...

## ■ Set Camp On / Callback

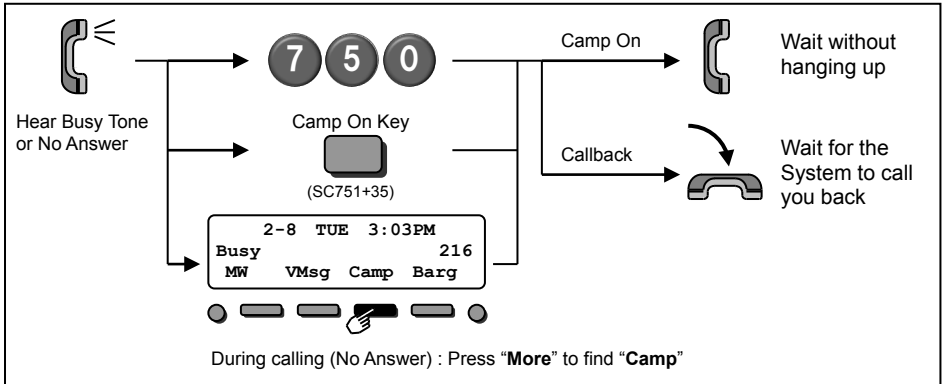

- **Camp On** In case of Intercom Call, when you hear ringing, wait for the called party to answer. In case of Outside Call, when you hear Dial Tone, begin telephone number dialing.
- **Callback** In case of Intercom Call, when your terminal starts the ringing, lift handset and wait for the called party to answer. In case of Outside Call, when your terminal starts the ringing, lift handset, hear Dial Tone, and begin telephone number dialing.
- This function is applicable in case all trunks are busy condition. (not applicable for dialed outside party busy)

## ■ Cancel Camp On / Callback

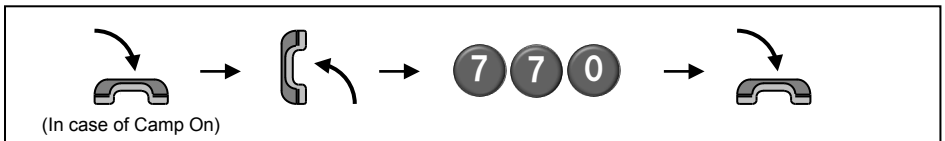

## ■ Repeat Dialing <Outside Call Only>

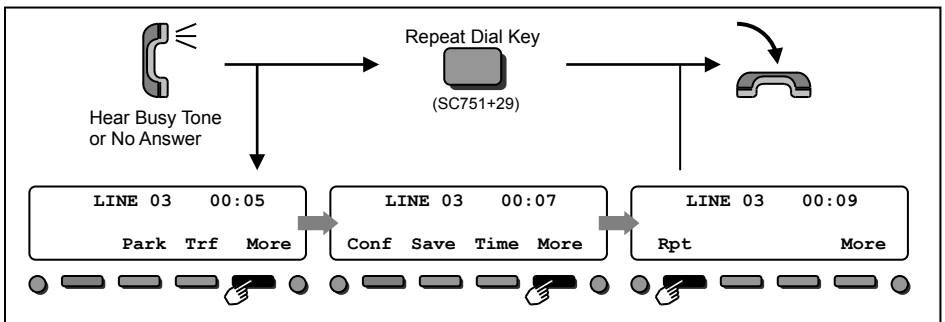

- When the Repeat Dialing is set, Repeat Dial Key shall flash and the system automatically and periodically redials a call. Repeat duration is programmable. Ask your NEC Authorized Supplier for the details.
- You should lift the handset when the called party answered.
- Press flashing Repeat Dial Key to cancel.

# If your call doesn't go through...

## ■ Set a Message Waiting

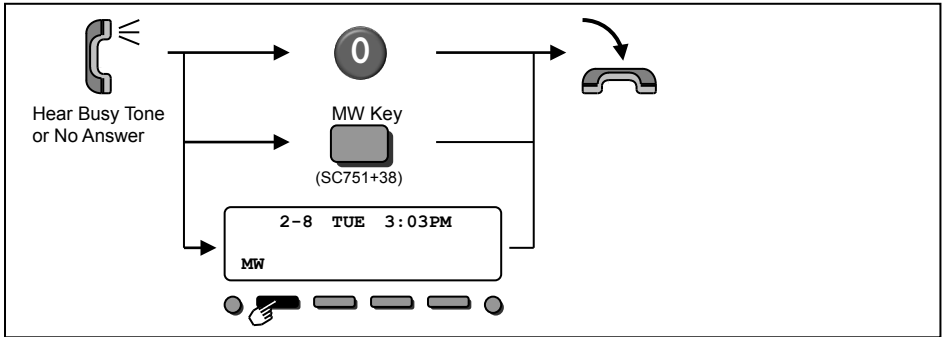

- When you set a MW, the called party's Indicator starts to flash, and your Indicator is lit in Red.

## ■ Answer a Message Waiting (Your terminal's Indicator is flashing in Red)

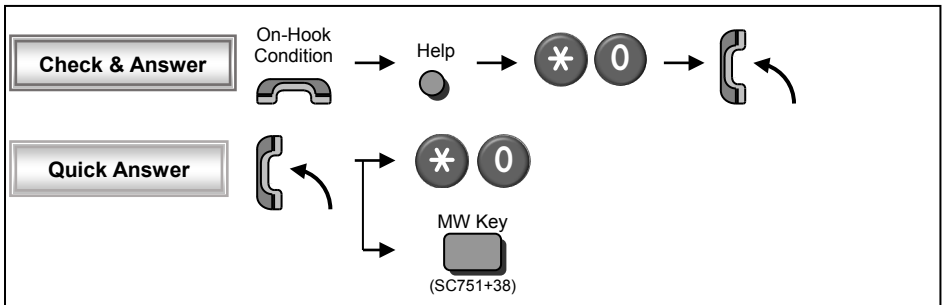

- When you answer a MW, the Indicator shall automatically be off when the called party answers.
- If multiple message are in queue, you can select the desired party by pressing Up key after dialing “\* , 0”, if several number of Message Waiting has been set.

## ■ Cancel Message Waiting

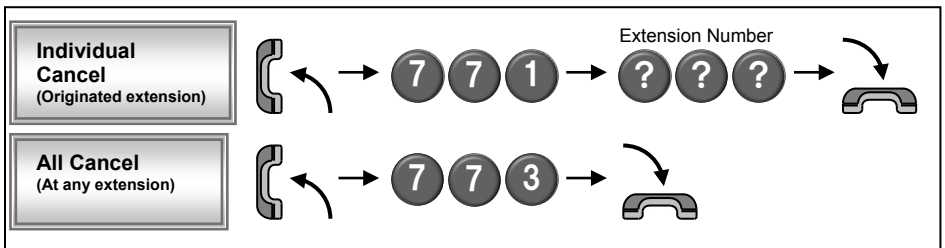

# Answering Calls

## ■ Answering an Outside Call

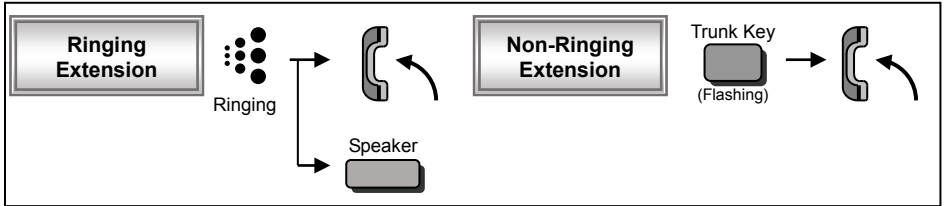

- Confirm the status of Mute Key if you want to answer by Handsfree. (Mute On : LED On, Mute Off : LED Off)

## ■ Answering an Intercom Call

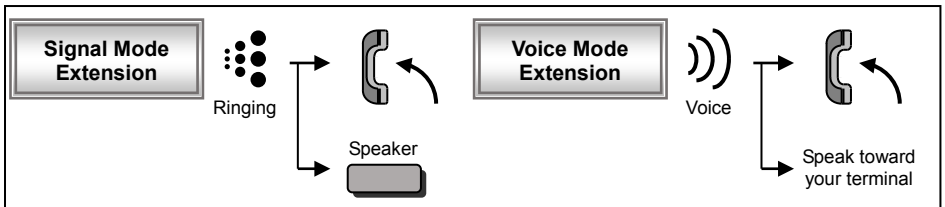

- Intercom Call Mode (Signal or Voice) can be set at your terminal by :  
 "Signal" : **Speaker -> 723** "Voice" : **Speaker -> 721**
- Confirm the status of Mute Key if you want to answer by Handsfree. (Mute On : LED On, Mute Off : LED Off)

## ■ Picking up a Call for other Extensions

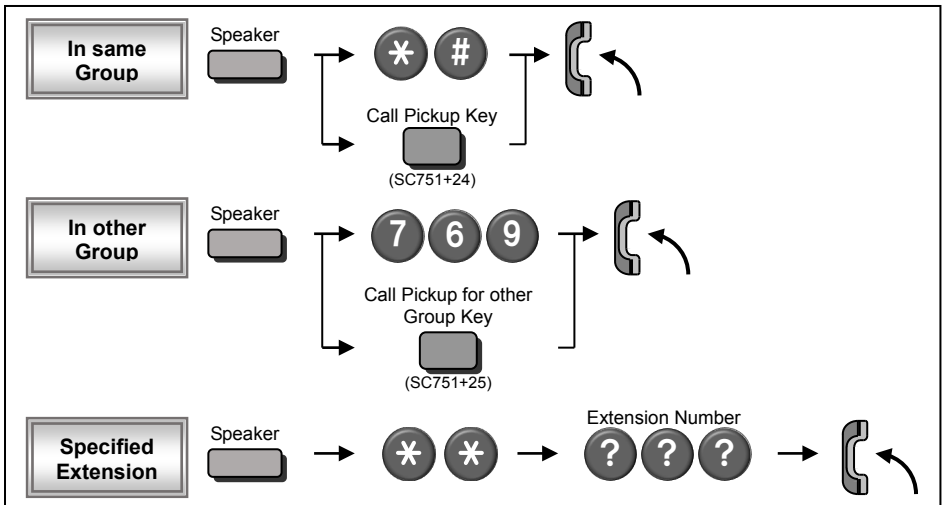

- System setting is necessary to create a Call Pickup Group. Ask your NEC Authorized Supplier for the details.
- Call Pickup operations are available using Soft Key operation.

# Hold / Transferring Calls

## ■ Holding a Call / Retrieving a Held Call

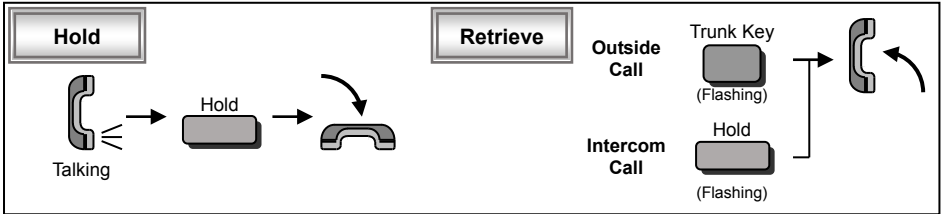

- In case of Intercom, the call shall be held as "Exclusive Hold" on your terminal.
- This operation puts your outside call on System Hold. Other extension user can take the call off Hold.

## ■ Holding a Call Exclusively

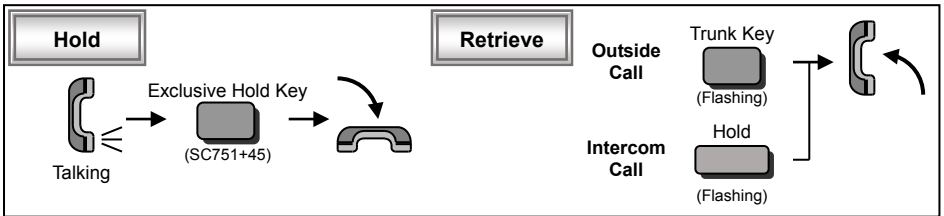

- This operation puts your outside call on Exclusive Hold. Other extension user can not take the call off Hold.

## ■ Retrieve a Held Outside Call

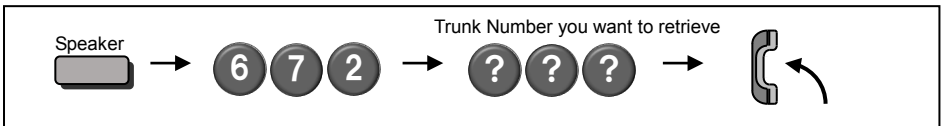

- Ask your NEC Authorized Supplier for the details about your Trunk Number dialing digits.

## ■ Transferring a Call to the other Extension

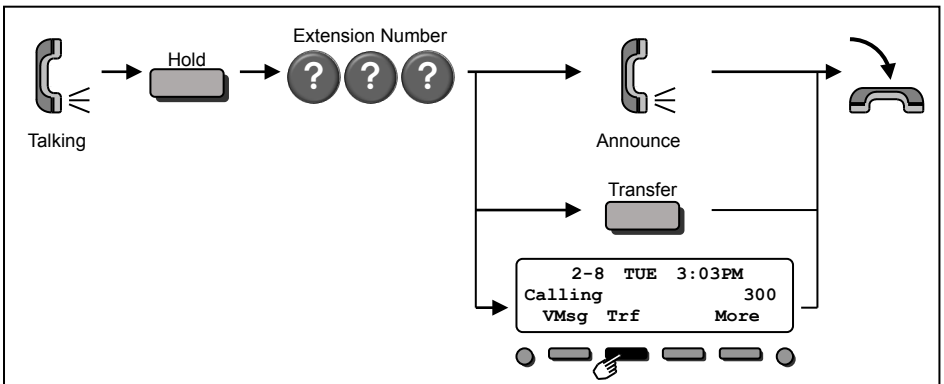

- If your terminal has DSS/One-Touch key, just press it instead of "HOLD" and "Extension Number" dialing.

# For more Convenient Use...

## ■ Do Not Disturb (DND)

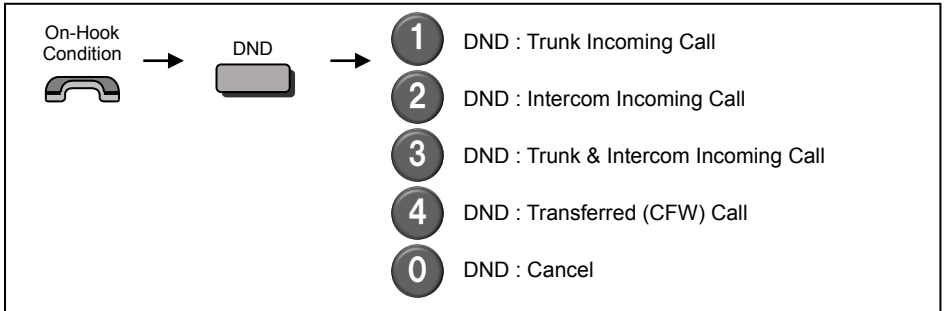

- When you set DND function, DND Key shall be lit and the Internal Dial Tone pattern shall be changed.

## ■ Conference

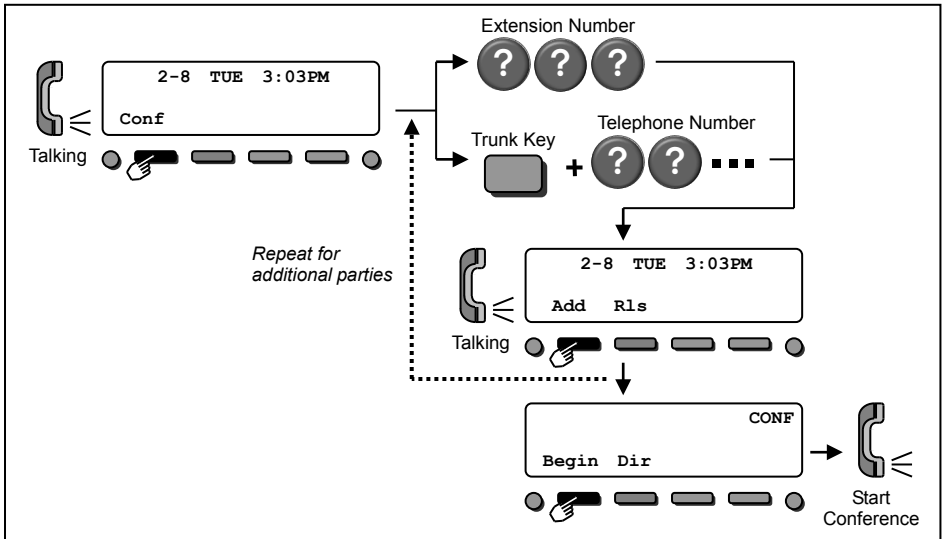

- You can repeat this operation to add more parties.
- You may be able to have up to 16 parties. (include your terminal) You may need to adjust the volume level due to the Environment where calls are placed. Ask your NEC Authorized Supplier for the details.

# For more Convenient Use...

## ■ Call Forwarding / Follow Me

When you set Call Forward / Follow Me, the destination extension shall be displayed on the LCD, and the Internal Dial Tone pattern shall be changed. (Call Forward / Follow Me can be set by Soft Key as well)

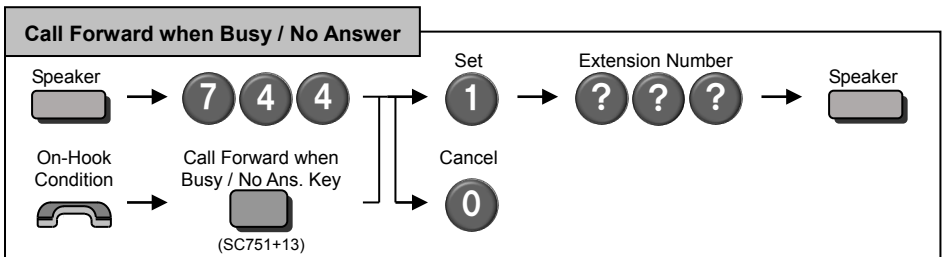
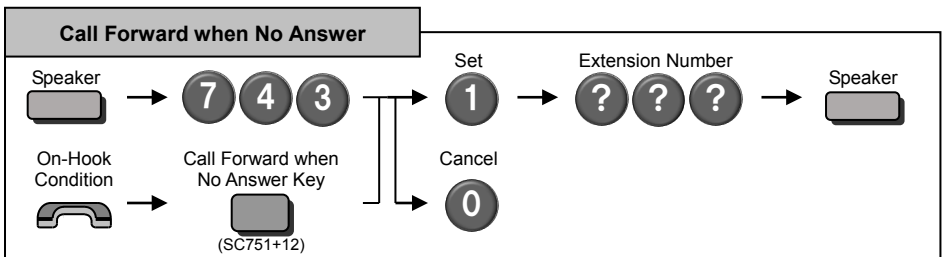
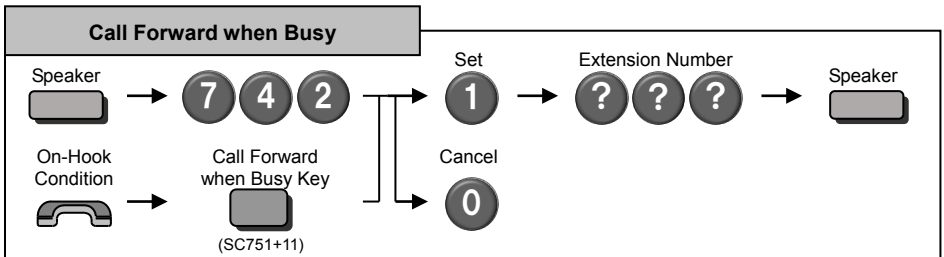
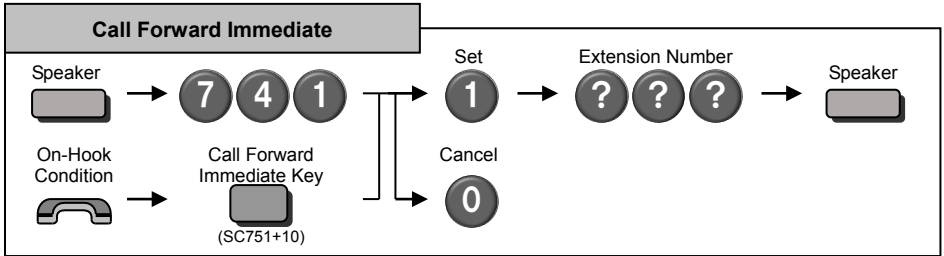

# For more Convenient Use...

## ■ Call Forwarding / Follow Me (Cont'd)

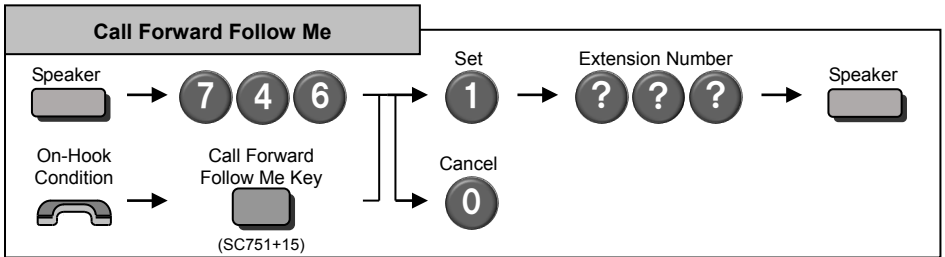
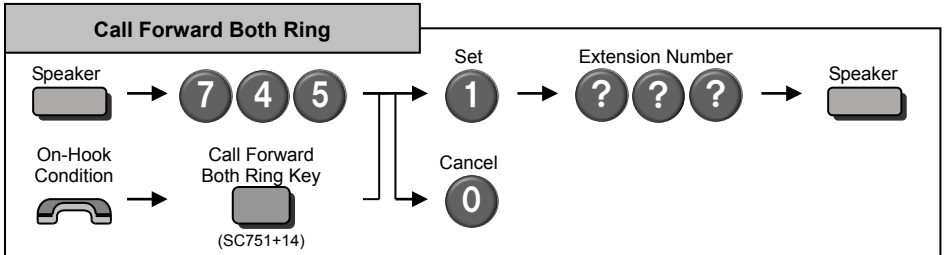



# Soft Keys Operation

## ■ “Menu” Soft Key

The following table shows the menu structure of “Menu” Soft Key. You can reach the desired feature by following operation.

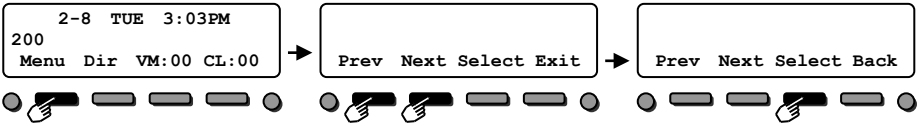

It is possible to search the desired feature by pressing Cursor the Keys (Up / Down / Right / Left) several times instead of “Prev” or “Next” Soft Keys, it’s also possible to access the desired feature directly by dialing the 2 digit Menu Code after pressing the “Menu” Soft Key.

| Item                            | Menu Code   | Next Operation after pressing the “Select”  |
|---------------------------------|---|---|
| <b>10 : Volume Preferences</b>  | 11 : Ring<br>12 : Off-Hook Ring   | Press “Down” or “Up” to adjust the selected option.   |
| <b>20 : Display Preferences</b> | 21 : Contrast<br>22 : Minimum Brightness<br>23 : Maximum Brightness   | Press “Down” or “Up” to adjust the selected option.   |
| <b>30 : Feature Preferences</b> | 31 : Voice Announce<br>32 : Handsfree Reply<br>33 : Automatic Call Timer<br>34 : Preview Dial<br>35 : Illuminated Dialpad<br>36 : Auto Call Screening<br>37 : Incoming Page<br>38 : Ringing Line Preference   | For the selected option, press “On” (enable) or “Off” (disable).  |
| <b>40 : Ring Preferences</b>    | 41 : Intercom<br>42 : Line Keys<br>43 : Each Line Keys  | Press “<<” or “>>” to select and save option.   |
| <b>50 : Key Assignments</b>     | 51 : Feature Keys<br>52 : Primeline Key   | Press “<<” or “>>” to select and save option.   |
| <b>60 : Call Forwarding</b>     | 61 : Immediate<br>62 : Ring No Ans<br>63 : Busy No Ans<br>64 : Call Forward AME<br>65 : Display Message<br>66 : Follow Me<br>67 : Both Ring   | Press “Set” or “Cancel”, enter the destination and select option to save.   |
| <b>70 : Speed Dial</b>          | 71 : Personal Speed Dial<br>72 : Company Speed Dial   | Enter Bin number and Phone number, Name and save.   |
| <b>80 : Name and Language</b>   | 81 : Extension Name<br>82 : Display Language  | For Name, enter the name using Alphanumeric Characters, For Language, press “<<” or “>>” to select and save.                              |
| <b>90 : Option Preferences</b>  | 91 : Headset Mode<br>92 : Headset Voice Announce<br>93 : System Information<br>94 : VoIPDB Information<br>95 : Not Used<br>96 : IP Address Information<br>97 : IP Phone log off<br>98 : Change login password | For Headset option, press “On” (enable) or “Off” (disable).<br>For System / VoIPDB information (IP Address, MAC Address), press “Select”. |
| <b>00 : Admin</b>               | 01 : Time<br>02 : Date<br>03 : Extension Name<br>04 : Clear All Call Fwd<br>05 : System Night Key Mode  | For Time, Date and Extension Name, enter the Time, Date and Extension Number and Name to save. For Clear All Call Fwd, press “Yes”.       |

# Soft Keys Operation

## ■ “Dir” Soft Key

You can activate the Directory Dialing feature by pressing the “Dir” Soft Key.

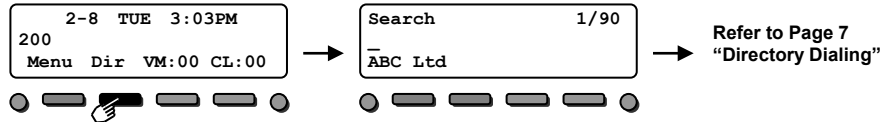

## ■ “VM” Soft Key

Number of new messages in your mailbox is displayed on the “VM” Soft Key; you can access your mailbox by pressing this key.

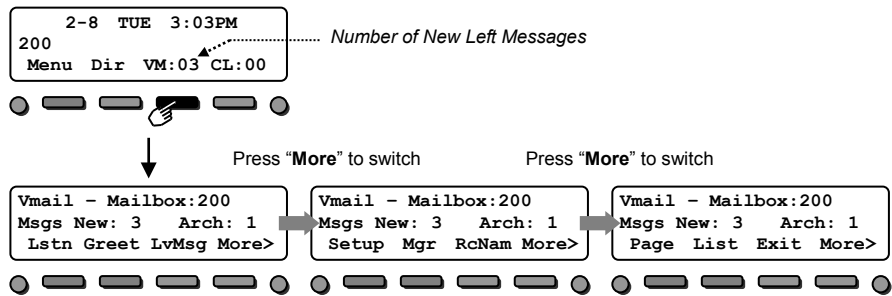

| Soft Key Indication | Feature                 | Next Operation after pressing Soft Key  |
|---------------------|-------------------------|---|
| <b>Lstn</b>         | Listen to Left Messages | Press “ <b>Next</b> ” to play next message, press “ <b>Rplay</b> ” to repeat played message, press “ <b>Del</b> ” to delete played message. Press “ <b>More</b> ” for other Mailbox features.                         |
| <b>Greet</b>        | Mailbox Greeting        | Press one of “ <b>Gr1</b> ” / “ <b>Gr2</b> ” / “ <b>Gr3</b> ” to choose the desired personal greeting message, and press “ <b>Lstn</b> ” (Listen) / “ <b>Rec</b> ” (Record) / “ <b>Del</b> ” (Delete) to maintain it. |
| <b>LvMsg</b>        | Leave Message           | Start message recording and press “ <b>Done</b> ” to complete it. Dial extension number you want to send this message and press “ <b>Send</b> ”.  |
| <b>Setup</b>        | Mailbox Option Menu     | Press “ <b>Code</b> ” (Security Code) / “ <b>Notfy</b> ” (Message Notification) / “ <b>CallH</b> ” (Call Handling Option) / “ <b>ATime</b> ” (Auto Time Stamp) to maintain each mailbox option.                       |
| <b>RcNam</b>        | Name Menu               | Press “ <b>Lstn</b> ” (Listen) / “ <b>Rec</b> ” (Record) / “ <b>Del</b> ” (Delete) to maintain the Mailbox Name.  |
| <b>Page</b>         | Page Message Menu       | Press “ <b>Lstn</b> ” (Listen) / “ <b>Rec</b> ” (Record) / “ <b>Del</b> ” (Delete) to maintain the Paging Message.  |
| <b>List</b>         | Message List            | Press “ <b>All</b> ” / “ <b>New</b> ” / “ <b>Arch</b> ” to set the message listen mode (message list) which you want to listen.   |
| <b>Exit</b>         | Exit VM Menu            | - - -   |

# Soft Keys Operation

## ■ “CL” Soft Key

Number of new unanswered calls is displayed on the “CL” Soft Key; you can access your Caller-ID List by pressing this key.

2-8 TUE 3:03PM  
 Check List  
 Menu Dir VM:00 CL:02



Total:05 New:02  
 Unans:03 Ans:02  
 All Unan Del Exit



01: 12349876  
 2-6 13:19  
 Call Store Del More



| Soft Key Indication | Feature                 | Next Operation after pressing Soft Key                              |
|---------------------|-------------------------|---|
| All                 | All Incoming Calls List | See below   |
| Unan                | Unanswered Calls List   | See below   |
| Del                 | Delete List             | Press “Yes” to delete all Caller-ID List. (or press “No” to cancel) |
| Exit                | Exit from Summary       | - - -   |

Press  
 “More”  
 to switch



01: 12349876  
 2-6 13:19  
 Edit Back More



Press “VOL Up /  
 Down” Keys to  
 select the  
 desired number.

| Soft Key Indication | Feature                  | Next Operation after pressing Soft Key   |
|---------------------|--------------------------|--|
| Call                | Call to displayed number | Lift the handset to talk when the destination answered.  |
| Store               | Store displayed number   | Press “STA” (Personal Speed Dial) or “Abb” (Common Abbreviated Dial), and dial Bin Number to store the displayed number with name. (Press Hold Key to save.)     |
| Del                 | Delete displayed number  | Next received Caller-ID shall be automatically displayed, and continue the Caller-ID Soft Key operation.   |
| Edit                | Edit displayed number    | Press “<-” or “->” to change the cursor position, press “DEL” to delete a digit, and dial new digit. (Press Hold Key to save.) Press “CNCL” to cancel Edit Mode. |
| Back                | Return to Summary        | Continue the Caller-ID Soft Key operation.   |

# Soft Keys Operation

## ■ Soft Key Operations during Off-Hook condition

When you press the Speaker Key or lift the handset, you will see the following Soft Keys.

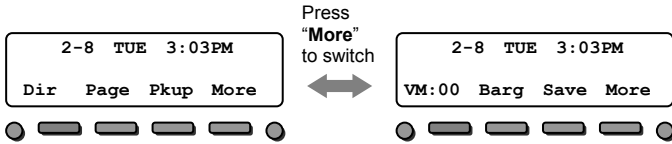

| Soft Key Indication | Feature           | Next Operation after pressing Soft Key   |
|---------------------|-------------------|--|
| <b>Dir</b>          | Directory Dialing | Refer to Page 7 for Directory Dialing operation.   |
| <b>Page</b>         | Paging            | Press " <b>InPg</b> " (Internal Paging) or " <b>ExPg</b> " (External Paging), and dial the Group/Zone number to page.                                    |
| <b>Pkup</b>         | Call Pickup       | Press " <b>Pers</b> " for Extension Call Pickup.<br>Press " <b>ExPg</b> " for External Paging pickup<br>Press " <b>InPg</b> " for Internal Paging pickup |
| <b>VM:00</b>        | Mailbox Access    | Refer to Page 17 (VM Soft Key)   |
| <b>Barg</b>         | Barge-In          | Dial the target extension number to barge in.  |
| <b>Save</b>         | Saved Number Dial | Saved number is dialed automatically. Wait for answer.   |

## ■ Soft Key Operations during Intercom Calling

During Intercom calling (called party does not answer yet), you will see the following Soft Keys.

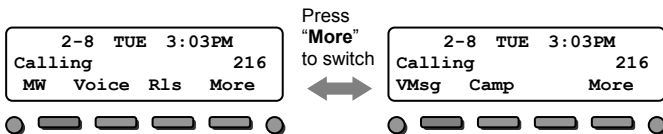

| Soft Key Indication   | Feature                                       | Next Operation after pressing Soft Key  |
|-----------------------|---|---|
| <b>MW</b>             | Message Waiting                               | Message Waiting is set. Hang up to finish.  |
| <b>Voice (Signal)</b> | Intercom Call Mode Switching (Signal / Voice) | Signal -> Voice : Start to talk after beep tone.<br>Voice -> Signal : Wait for called party answer.<br>Press " <b>Voice</b> " (or " <b>Signal</b> ") again to switch Call Mode, if necessary. |
| <b>Rls</b>            | Hang Up                                       | ---   |
| <b>VMsg</b>           | Leave a Message (In-Mail) (Option)            | Start recording your message.   |
| <b>Camp</b>           | Camp On / Callback                            | <u>Camp On</u><br>Wait for the system to call you back without hanging up.<br><u>Callback</u><br>Hang up and wait for the system to call you back.  |

# Soft Keys Operation

## ■ Soft Key Operations after establishing an Intercom Call

After establishing an Intercom call, you can use following feature by Soft Key.

2-8 TUE 3:03PM  
Talking To 216  
Conf



Refer to Page 13  
"Conference"

| Soft Key Indication | Feature    | Next Operation after pressing Soft Key  |
|---------------------|------------|---|
| Conf                | Conference | Dial the desired extension number, or seize an idle trunk and place a call to establish a conference. Press "Conf" to invite the other party, or press "Add" and "Begin" to start a conference. Press "AnHd" to retrieve a held call. |

## ■ Soft Key Operations during Outside Call

When you seize a trunk for outgoing call, or you answered an incoming call, you can use following features by Soft Key.

(When you seize a Trunk)

LINE 03  
Lnd Save Rls Acct



After establishing call and pass 4 seconds

Press "More" to switch

LINE 03  
Park Trf More

LINE 03  
Conf Save Time More

LINE 03  
Rpt More



| Soft Key Indication | Feature                     | Next Operation after pressing Soft Key                       |
|---------------------|-----------------------------|--|
| Lnd                 | Last Number Dialing         | Last dialed number is dialed automatically. Wait for answer. |
| Save                | Saved Number Dialing        | Saved number is dialed automatically. Wait for answer.       |
| Rls                 | Hang Up                     | - - -  |
| Acct                | Account Code Entry (Option) | Enter the Account Code.                                      |

| Soft Key Indication | Feature                       | Next Operation after pressing Soft Key   |
|---------------------|-------------------------------|--|
| Lnd                 | Last Number Dialing           | Last dialed number is dialed automatically. Wait for answer.   |
| Park                | Park Hold                     | Press "Sys" (System Park) or "StaP" (Extension Park) to select type of Park Hold.  |
| Trf                 | Transfer                      | Dial the desired extension number, or seize an idle trunk and place a call to transfer.  |
| Conf                | Conference                    | Dial the desired extension number, or seize an idle trunk and place a call to establish a conference. Press "Add" to invite the other party, or press "Add" and "Begin" to start a conference. Press "AnHd" to retrieve a held call. |
| Save                | Save dialed Number            | - - -  |
| Time                | Call Duration Time Indication | Press "Time" again to turn off the Call Duration Time indication.  |
| Rpt                 | Repeat Dialing                | Repeat Dialing feature is set, and the system automatically places a call periodically. Wait for answer.   |

# Cursor Keys Operation

## ■ Menu Structure when PRG15-02-60 is set to Advanced Mode 1

The following table shows the menu structure of the Cursor Keys. You can reach the desired menu by pressing Navigation Keys (Up / Down / Right / Left) or dial 3 digits for shortcut access after pressing the "Enter Key" to activate a menu.

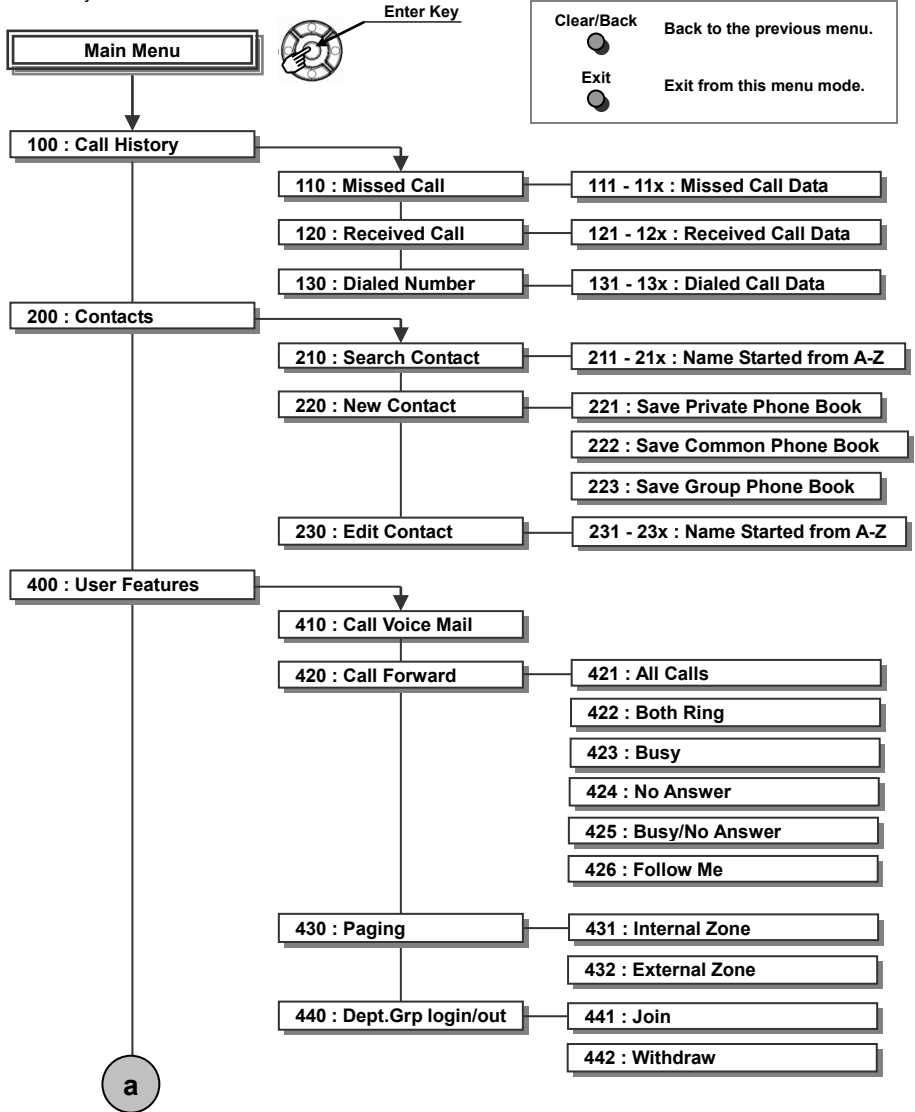

# Cursor Keys Operation

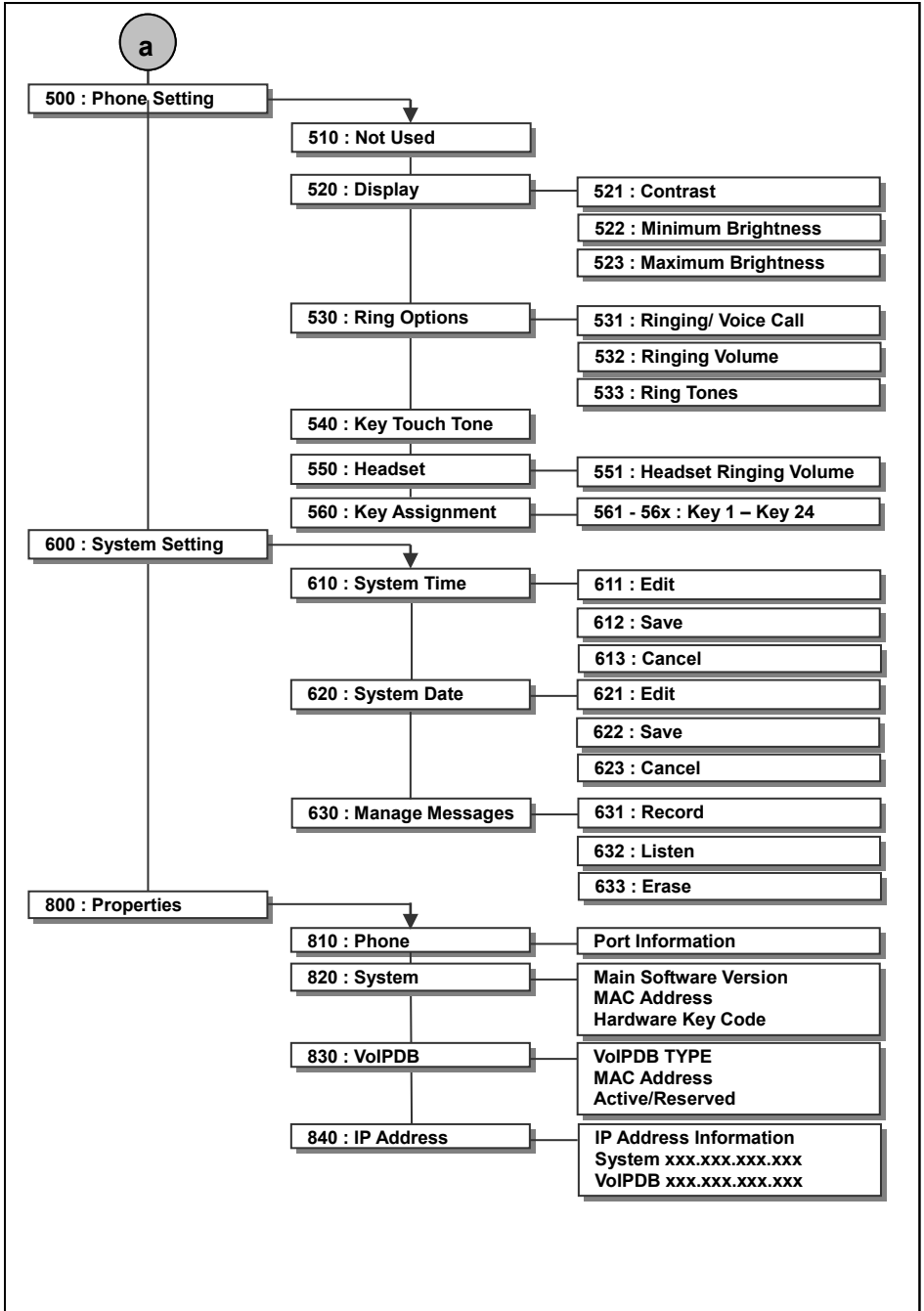

# Built-In Automated Attendant

System setting is necessary to use Built-In Automated Attendant. Ask your NEC Authorized Supplier for the details.

## ■ Record / Listen / Erase Answering Messages

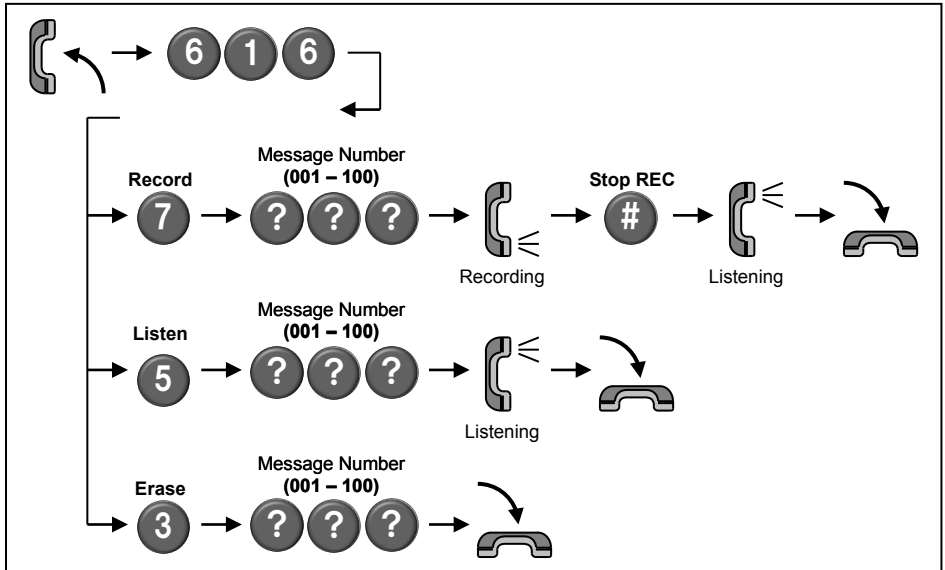

- Up to 100 types of messages can be recorded.
- The Message length can not exceed 4 minutes.



# In-Mail (Voice Mail)

Optional hardware and System setting is necessary to use In-Mail (Voice Mail) feature. Ask your NEC Authorized Supplier for the details.

## ■ Log-On to the In-Mail

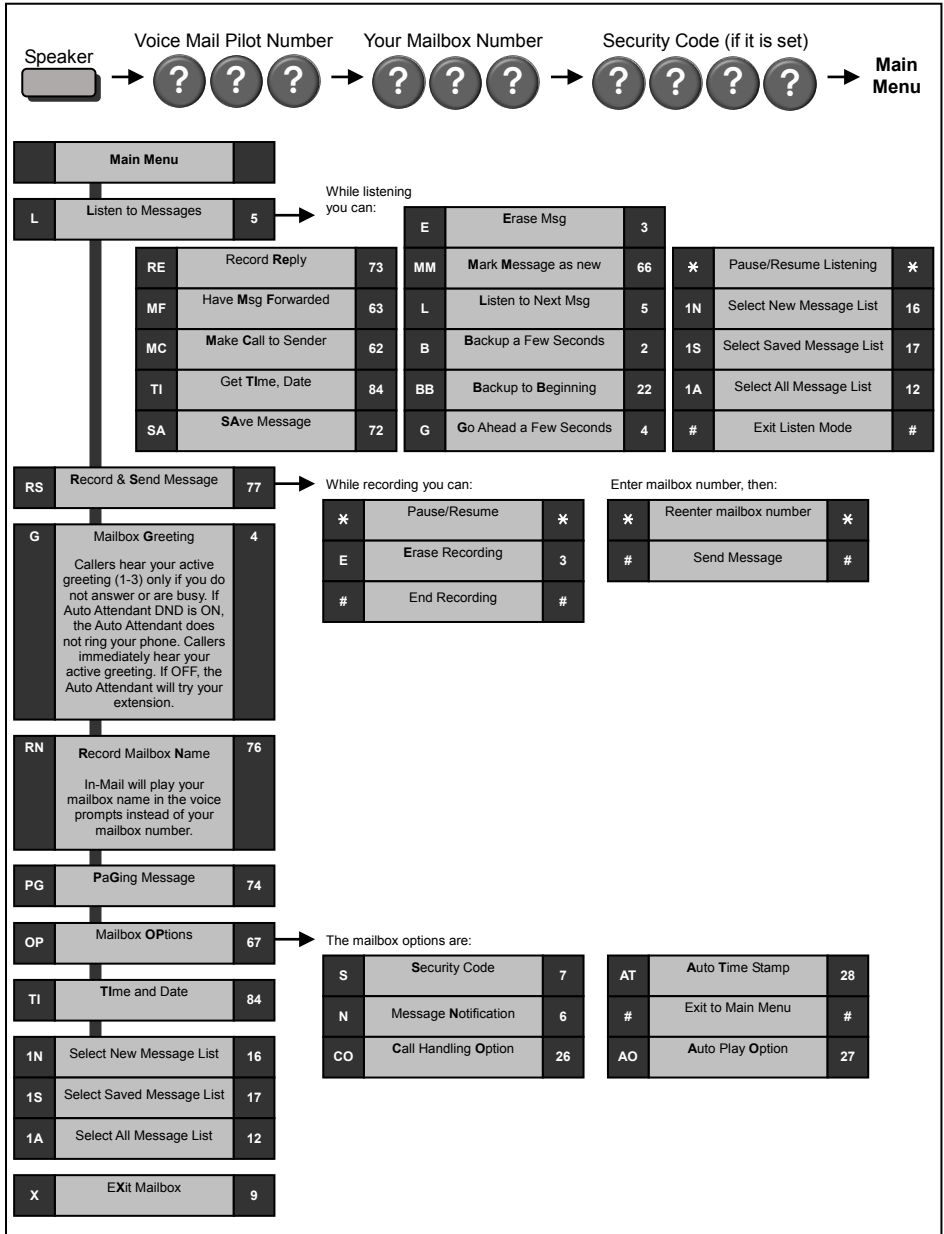

# In-Mail (Voice Mail)

## ■ Call Forward to Voice Mail

### Convenient Operation by Function Key



Auto-Attendant Key



(SC751+79 + Ext No.)

Press "Automated Attendant" Key several times to change the status. (All Calls -> No Answer -> Busy -> Busy/No Answer -> Cancel)

### Forward All Incoming Calls

Speaker



7 4 1



Call Forward Immediate Key



(SC751+10)



Set

1

Cancel

0

Voice Mail Pilot Number

? ? ?

Speaker



### Forward Incoming Call when Busy

Speaker



7 4 2



Call Forward when Busy Key



(SC751+11)



Set

1

Cancel

0

Voice Mail Pilot Number

? ? ?

Speaker



### Forward Incoming Call when No Answer

Speaker



7 4 3



Call Forward when No Answer Key



(SC751+12)



Set

1

Cancel

0

Voice Mail Pilot Number

? ? ?

Speaker



### Forward Incoming Call when Busy / No Answer

Speaker



7 4 4



Call Forward when Busy / No Ans Key



(SC751+13)



Set

1

Cancel

0

Voice Mail Pilot Number

? ? ?

Speaker



# In-Mail (Voice Mail)

## ■ Mailbox Greeting

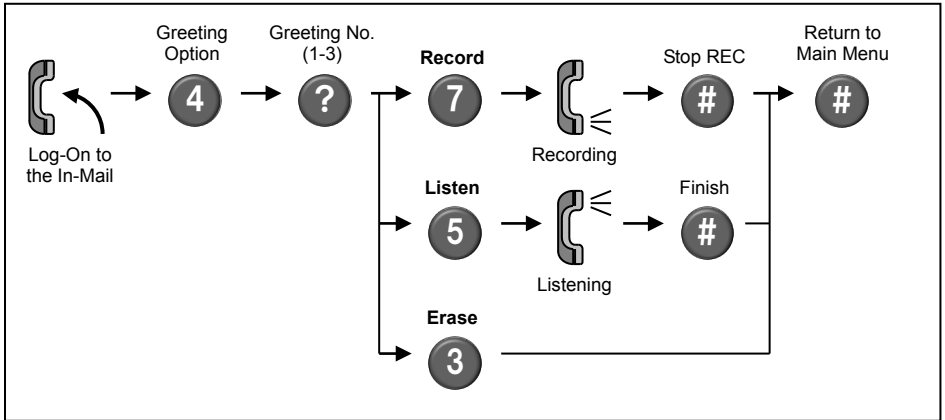

- Selected Greeting (one of three) shall be made active.

## ■ Mailbox Security Code

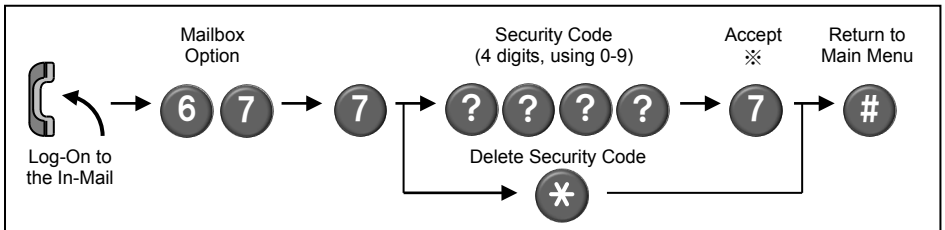

※ The type of Security Code can be assigned as below.

- Dial 4 digits Security Code followed by "7": Security Code for all log-on
- Dial 4 digits Security Code followed by "6": Security Code for remote log-on only
- System Administrator can delete a Mailbox Security Code.

# In-Mail (Voice Mail)

## ■ Listen to Left Messages in your Mailbox

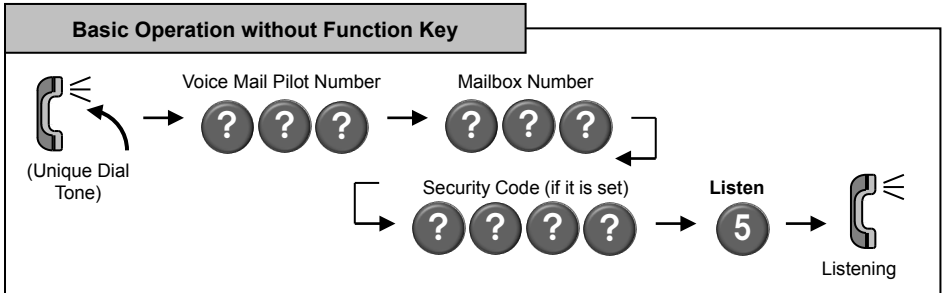
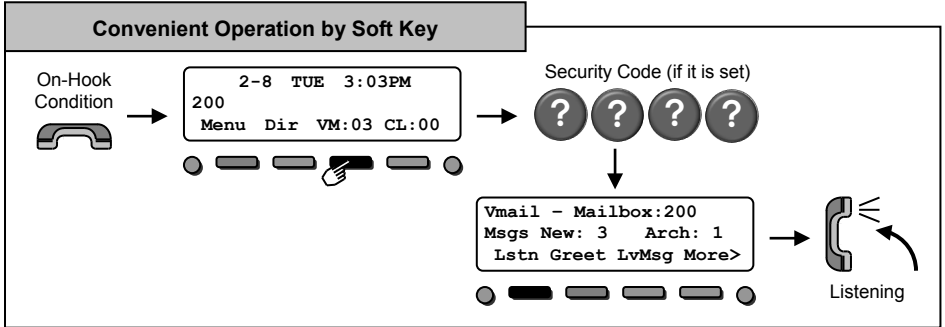
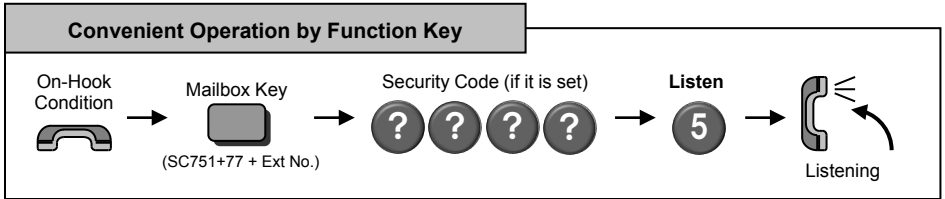

# In-Mail (Voice Mail System Administrator)

The following administrative features are only available at the system administrator's extension (extension 101 at default). Ask your NEC Authorized Supplier for details on how to become a system administrator..

## ■ Log-In to the In-Mail

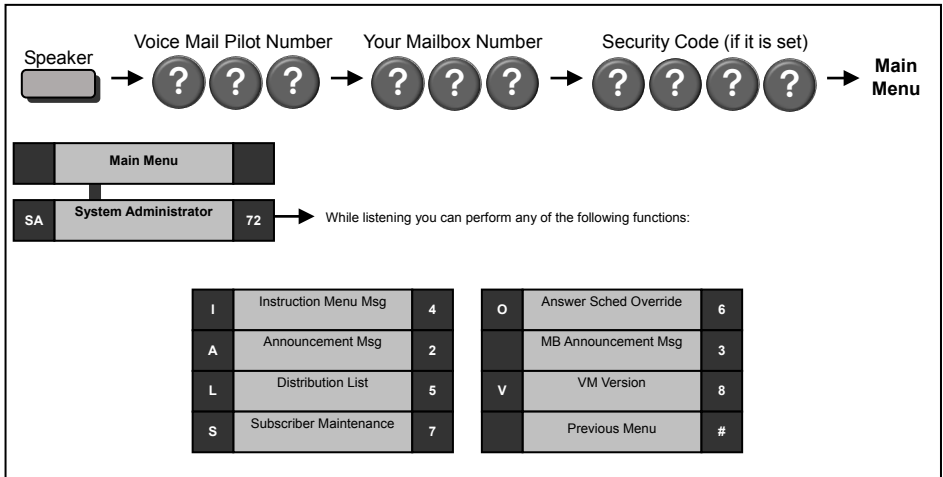

- ◆ **Instruction Menu Message** are used as the Automated Attendant Main Greetings (e.g. Day Mode greeting, Night Mode greeting, etc)
  - To record an instruction Menu from the System Administrator Menu, dial the digit **4** (Instruction Menu Messages). Dial the mailbox number (**001 – 032**).
  - Press the digit **5** to **Listen** to the message.
  - Press the digit **7** to **Record** the message.
  - Press the digit **3** to **Delete** the message.
  - Press # to return to the System Administrator Menu.
- ◆ **Announcement Message** are used to announce general information to callers such as directions, hours of operation, etc.
  - To record an Announcement Message from the System Administrator Menu, dial the digit **2** (Announcement Messages). Dial the mailbox number (**001 – 032**).
  - Press the digit **5** to **Listen** to the message.
  - Press the digit **7** to **Record** the message.
  - Press the digit **3** to **Delete** the message.
  - Press # to return to the System Administrator Menu.
- ◆ **Distribution List** is a list of extensions set to receive a single voice mail message. Any message left in the distribution mailbox will be sent to all extensions in the list.
  - To review or modify the Distribution List from the System Administrator Menu, dial the digit **5** (Distribution List). Dial the mailbox number (**001 – 032**) to be modified..
  - ▶ Press the digit **6** to **Review** or **Modify** the list.
  - Press the digit **2** to **Add** an extension to the distribution list.
  - Press the digit **3** to **Delete** the current extension from the list.
  - Press the digit **6** to step to the **Next** entry.
  - Press # to return to the System Administrator Menu.
  - ▶ Press the digit **76** to record a **Name** for the distribution list.
  - Press the digit **5** to **Listen** to the name.
  - Press the digit **7** to **Record** a new name.
  - Press the digit **3** to **Delete** the name.
  - Press # to exit this feature.
  - ▶ Press # to return to the System Administrator Menu.

# In-Mail (Voice Mail System Administrator)

- ◆ **Subscriber Maintenance** is used to modify the subscriber mailboxes.
  - To modify a Subscriber Mailbox from the System Administrator Menu, dial the digit **7** (Subscriber Maintenance). Dial the **extension number** of the mailbox you wish to modify.
  - Press the digit **32** to **Delete** all messages.
  - Press the digit **34** to **Delete** the mailbox greeting.
  - Press the digit **36** to **Delete** to the mailbox name.
  - Press the digit **7** to **Delete** the security code.
  - Press the digit **6** to **Record** a new name.
  - Press # to return to the System Administrator Menu.
- ◆ **Answer Schedule Override** provides alternate answering for the Automated Attendant by sending calls to a specified Override mailbox, when enabled. As an example you can use the Answering Schedule Override to provide Holiday and Bad Weather closing announcements.
  - To modify the Answer Schedule Override from the System Administrator Menu dial **6** (Answer Schedule override). Dial the answer table number (**01-16**) you wish to override.
  - Press the digit **6** to toggle **On/Off** the answer schedule table.
  - Press the digit **2** to enter a **New** answer schedule override mailbox. Enter the override mailbox number (**001-032 or a valid subscriber extension**). The override mailbox can be an announcement, call routing box, or a subscriber box.
  - Press # to return to the System Administrator Menu.
- ◆ **Mailbox Announcement Message** is a message recorded by the system administrator that plays to each subscriber when they log into their mailbox. This message will play each time the subscriber logs into their box until it expires, is deleted, or is made inactive by the system administrator.
  - To record and modify the Mailbox Announcement Message from the System Administrator Menu, dial the digit **3** (Mailbox Announcement Message).
  - Press the digit **5** to **Listen** to the mailbox announcement message.
  - Press the digit **7** to **Record** a new mailbox announcement message.
  - Press the digit **3** to **Delete** the mailbox announcement message.
  - Press the digit **2** to **Specify** the amount of days the message is active. Enter \* for an indefinite amount of days or enter **01-99** for 1-99 days.
  - Press # to return to the System Administrator Menu.
- ◆ **Voice Mail Version** will play a message indicating the software level of the voice mail.
  - To hear the current Voice Mail Version from the System Administrator Menu, dial the digit **8** (Voice mail Version).

# MEMO

GVT-025184-301-00  
Issue 1.0  
May 2017

# ***SL2100***

IP Multiline Terminal  
User Guide

**NEC Corporation**